

Data Communication Introduction

Data Communication Explained

Data communication is fundamentally a simple operation. Point A sends information to Point B and Point B receives it. A slightly more complex, and more practical, system allows Point A to send information to and receive information from Point B, and vice versa. It is what lies between points A and B that has been the substance of data communication system development since before the personal computer, or any computer for that matter, was ever invented.

For example, consider several simple examples of data communication systems that have nothing to do with computers: Paul Revere used a very basic system, whereby one light in the tower signified the British were approaching by land, and two indicated they were approaching by sea. During a game of blind-man's-bluff, the subject hears a sound when he comes within a certain distance of an object, and nothing when he is out of range. To solve the problem of knowing when dishes in a dishwasher are clean or dirty, a family might decide to place a black magnet on the dishwasher when dirty dishes are put in, and then change it to a white magnet when the cleaning cycle is started, and return the black magnet after it is emptied. The one thing all these examples have in common is that they all use two-state systems of communication. A two-state system is one which uses only two possible values to transmit information--the lamp is on or it is off, there is a sound or there is silence, the magnet is black or white, etc. The way these values are combined allows complex messages to be transmitted using very simple tools.

Consider Morse Code, a two-state data communication system that functions very similarly to today's computerized data communication systems. Developed by Samuel E.B. Morse in the 19th century, Morse code uses electrical current to transmit a series of dashes and dots that represent letters of the alphabet, numbers, a comma and a period. A basic Morse Code transaction works as follows: A "message" is given to an operator who translates that message into dots and dashes (Point A), then the transmitting operator uses the telegraph key to send an electrical signal to the receiving operator at the desired location to indicate that a message is about to come through. The receiving operator (point B) sends back an acknowledgment that he is ready, and the transmitting operator then sends the message which the receiving operator takes down. When the message is completely transmitted, the transmitting operator signals to the receiving operator that he is done, and the transmission line is closed. The receiving operator then translates the code back into the original message, and delivers it to the designated recipient.

Clearly, in a system of this type, accuracy is extremely important. As only two characters--dot or dash--are used to create a code for an entire language system, the transmitting and receiving operators must be extremely accurate. (Indeed, it makes a big difference whether the message says "Give one million dollars to Ted" or "Give one million dollars to Ned"--an easy mistake to make using Morse code, as the letter T is "-." and the letter N is "-.") This system can only work if both sides of the data communication system know the code and can encrypt and decode messages. It is also essential that the transmitter not send faster than the receiver can take-down the information. Even using expert operators, static on the line could obscure the signals making a dash sound like a dot and thereby corrupting the message. Thus, it becomes obvious that the most important aspect of designing a data communication system is ensuring not only that Point B can receive and understand the data transmitted by Point A, but also that the data remain uncorrupted during transmission.

These are the very same concerns faced by computerized data communication system designers. Indeed Morse code is often thought of as the forerunner of the computer's binary communication system. The binary system uses the numbers 0 and 1 as the symbols for transmission of data. Using positional notation, any value is represented by a weighted series of 1s and 0s. Thus the decimal number "33" would be represented by "100001" ($1 \times 2^5 + 0 \times 2^4 + 0 \times 2^3 + 0 \times 2^2 + 0 \times 2^1 + 1 \times 2^0$).

The above is a simple example of binary coding, but the same system is used by computers to transmit complex text messages, complex graphics, and streaming video. In order to accurately transmit many different types of data, numerous interfaces and protocols have been created. When selecting the appropriate equipment for your data communication application, it is important to examine both your application and the communication peripherals that must be incorporated into the system. First, determine whether your application is best suited for a wired system using cables or whether you need a wireless solution. Also determine whether you need a portable system using a laptop computer, or a desktop PC or Server. After deciding upon your host computer, determine the ports available, and the type of expansion boards this computer can best accommodate. Then, decide which of those options will best meet the speed and versatility demanded by your application. Once you've selected an interface, you can then begin to look at the type of data communication adapter you will need. You must also consider the distance you will need between the

Communication Overview

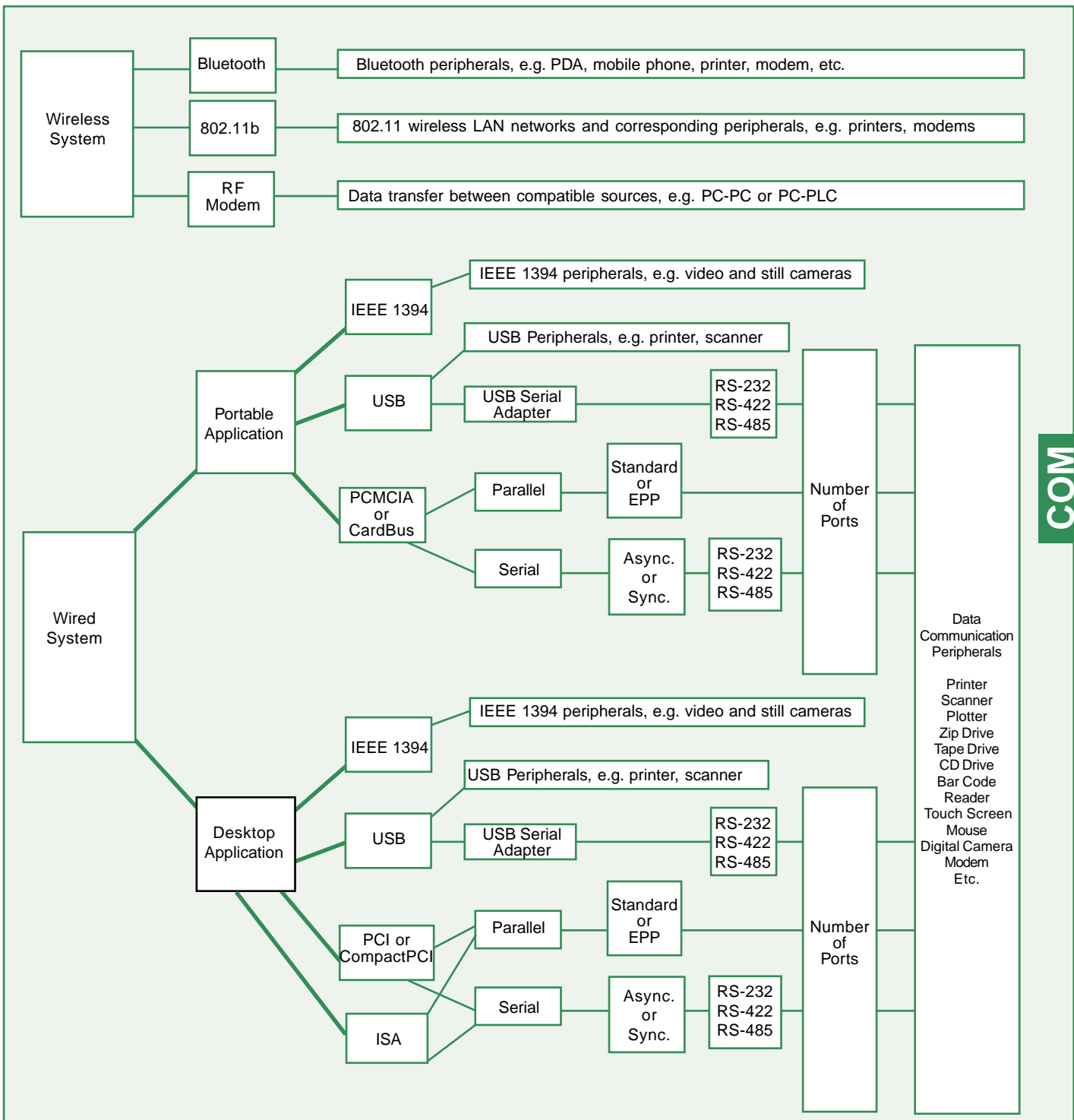

COM

(Assembling a Data Communication System)

communication peripherals and the host computer, as well as the data transfer speed required for your application to function properly. The number of peripherals you need to connect to the host computer is also important for determining how many ports must be added via expansion boards or hubs. The above flowchart provides an overview of this decision-making process. The sections

that follow provide detailed explanations of the options available at each step in the process.

ISA and MicroChannel

APPLICATION TYPE

The first step in assessing your data communication application is identifying which peripherals you will need and where you will need them. While in the past your choice of peripherals may have limited your options, today just about any serial or parallel device is available in portable form. Many of them are also available, or soon will be, for wireless networks.

There are no set rules for deciding between portable and desktop systems, or wired and wireless systems. However, common sense is your best guide. If your application requires traveling to multiple locations to download data, such as accessing an airplane's flight recorder from the cockpit for use in fleet maintenance, then a portable system could be an appropriate choice. However, if you are using a central computer to service a network of touch screens in a restaurant, then a desktop system might best serve your needs. If you are attempting to install a network in a factory to monitor equipment for preventive maintenance, running wires may be a problem, making a wireless system with high noise tolerance an ideal choice. See pages 36-40 in this section for application examples which cover a wide range of data communication systems. If you need help designing the optimal system for your application, call one of Quatech's expert sales engineers. We'd be pleased to help.

BUS OPTIONS

ISA

In The Beginning

The Industry Standard Architecture or ISA bus began as part of IBM's revolutionary PC/XT released in 1981. However, it was officially recognized as "ISA" in 1987 when the IEEE (Institute of Electrical and Electronics Engineers) formally documented standards governing its 16-bit implementation.

This first XT bus was intended to allow the addition of system options which could not be fit onto the motherboard. This XT bus was completely under the microprocessor's direct control, and its addressing width was limited to the 8-bit level of the processor. To make the bus useful, control lines were added to signal interrupts for input/output ports.

Bus speed was also limited to match the processor. The PC/XT's 8088 was a one-byte wide 4.77 MHz processor. Thus the XT bus, which required two clock cycles for data transfer, was limited to an excruciatingly slow (by today's standards) 2.38M bytes/sec, that could be curtailed even further if the system was busy with other tasks.

Modern 16-bit ISA

This modern ISA bus emerged in 1984 when it became clear to IBM developers that the advances made on the processor front had rendered the XT bus archaic. The first of these new processors--a 286--was designed to run at 8MHz with a full 16-bit data bus. IBM's PC/AT used this processor and contained an 8MHz bus to match it. Still limited by the two-clock-cycle data transfer, the new AT bus can reach speeds of only 8 Mbytes/sec. The AT bus provides 16 data lines and 24 address lines, thereby taking full advantage of the 16-bit addressing limit of the microprocessor. This improvement over the XT expands a PC's capability to accept add-in boards by including additional interrupts and DMA (direct memory access) channels. The ISA system, however, does not have a central registry from which to allocate system resources. Consequently, each device behaves as though it has sole access to system resources such as DMA, I/O ports, IRQs, and memory. Obviously, this can cause problems when using multiple add-in boards in a single system.

Another problem is caused by the limited number of available ports and interrupts on the system. Quatech has solved this problem for the ISA bus by developing a series of drivers which allow multiple devices to share the same interrupt. These drivers are available for Windows 3.1/95/98/NT, OS/2 and DOS. They permit any of Quatech's multi-port ISA serial adapters (see page 43 for selection guide) to share interrupts amongst themselves and with any other Quatech ISA serial device. To avoid confusion, our boards contain a register which will indicate the source of any interrupt.

ISA For Data Communication Applications

As shown in the table on the next page, ISA is the slowest and most limited of the bus options available today. If you want a Pc-based board-level solution, PCI appears to be the most logical choice. However, in practice there is no speed difference between running many serial communication peripherals using a PCI rather than an ISA bus. (Though the PCI advantage is obvious for high-speed devices such as video cards.) This is because of limitations inherent in the serial communication protocols (see page 25 for a discussion of serial communication). Thus Quatech's DSC-100 two port RS-232 serial PCI adapter has the same maximum baud rate as does our DS-100S two port RS-232 enhanced serial ISA adapter--115k bytes/sec (921.6 k bits/sec), well below the maximum 8M bytes/sec ISA limitation.

ISA cards are more cumbersome to install than other cards because I/O addresses, interrupts and clock speed must be set using jumpers and switches on the card itself. The other bus options that use

Type of Bus	Bus Clock Signal	Bus Width	Theoretical Max. Transfer Rate	Advantages	Disadvantages
ISA	8 MHz	16-bit	8 Mbytes/sec	low cost, compatible with older systems	low-speed jumper & DIP switches becoming obsolete
MCA	10 MHz	32-bit	40 Mbytes/sec	higher speed than ISA	obsolete
PCI	133 MHz	64-bit	1 Gbytes/sec	very high speed plug and play dominant board-level bus	incompatible with older systems can cost more
CompactPCI	33 MHz	64-bit	132 Mbytes/sec	designed for industrial use hot swapping/plug and play ideal for embedded systems	lower speed than PCI needs adapter for PC use incompatible with older systems
PCMCIA	10 MHz	16-bit	20 Mbytes/sec	ideal for portable systems hot swapping/plug and play	lower speed needs special drive for use in PCs
USB 1.1	n/a	n/a	1.5 Mbytes/sec	low cost ideal for portable systems hot swapping/ plug and play up to 127 devices via 1 port	slower than PCI and IEEE 1394 not compatible with older peripherals
IEEE 1394a	n/a	n/a	50 Mbytes/sec	high speed peer-to-peer communication hot swapping/plug and play up to 63 devices via one port	not compatible with older peripherals short communication distance (4.5M)

software to set these parameters are called Plug and Play. While there is nothing inferior about using jumpers and switches, it can be more intimidating for novice users.

The bottom line is that there is no reason to convert your current low-speed ISA serial communication systems to PCI, as ISA will provide equivalent functionality, generally at a lower price. However, many PCs now do not contain ISA slots, and the ISA interface is fast on its way to being phased out completely. If you are starting a new installation using a PC without ISA slots, if you prefer using Plug and Play boards, or you have a high-speed application, then you should consider using a different interface.

MicroChannel

A Good Idea Which Never Caught On

MicroChannel was introduced in 1987 by IBM as a solution to the inadequacy of the ISA bus. However, because MicroChannel (MCA) was prohibitively expensive, and since it was not backward compatible with older systems, the bus never caught on. It merits brief discussion here because design features first implemented in the MicroChannel architecture are at the heart of all subsequent bus designs.

Improvements Over ISA

The MCA bus itself, operating at 10MHz, was not enormously faster than its ISA predecessor, but its implementation provided for dramatically increased system performance. With MCA, IBM took bus control away from the processor and set up a system of

hardware-mediated bus sharing, whereby individual devices could temporarily take control of the system. This significantly lightened system overhead and allowed for much faster processing. In some systems the MCA bus could reach speeds of 40M bytes/sec, a significant improvement over ISA.

MCA improved over ISA in other ways as well, such as allowing 4-byte data transfers. To minimize interference, a ground or a power supply conductor was located within 3 pins of every signal. With the bus mastering feature, the MCA bus allowed multiple devices to compete for system resources at once. To avoid potential conflicts this could create, a burst mode feature was designed, which would exclusively allocate system resources to a single device for 12ms periods.

The First Plug and Play Boards

Another large improvement in the MCA architecture was the introduction of Plug and Play boards. Gone was the necessity to set jumpers and cables, MCA cards are automatically configured using a utility program which reads a unique identity number coded into a board's firmware. An MCA system uses CMOS memory to remember its system configuration. At setup it compares its file to the hardware installed, and makes necessary adjustments. The identity numbers on each board correspond to instructions indicating how the board should function within the system hierarchy. All MCA boards use the same setup procedure which is totally handled by the system, making the process appear seamless.

PCI

A New Standard

First released in 1992, the Peripheral Component Interface (PCI) has rapidly evolved into a viable replacement for the ISA bus, and is the most commonly used method for adding boards to a PC. It solves many of the problems with older architectures, while at the same time delivering a substantial increase in processing speed. PCI provides a new way of connecting peripherals to both the system memory and the CPU, with the goal of alleviating many problems encountered when installing new cards in an ISA based system (IRQ conflicts, address conflicts, etc.). To ensure the longevity of the bus, not only are systems based on newer PCI specifications backward compatible with those designed to older ones, PCI boards may also be used in a system that also employs other types of devices.

Strict Rules

To ensure that every PCI card will function properly in every PCI enabled system, a committee, the PCI Special Interest Group, was formed to set and manage standards for the bus. Quatech is a voting member of this committee, and all Quatech PCI products strictly adhere to the standards.

The most important of these standards is the requirement that all PCI cards implement specific configuration registers. Whether the PCI device is embedded on the PCI bus, or is an add-in board as Quatech's products are, it must include a unique "Vendor ID" and "Device ID," and a resource requirement list on its configuration registers. Any card which does not contain these registers cannot be considered a true "PCI" adapter, and might not work properly in your system. See pages 16-17 for a detailed discussion of PCI compliance issues and a comparison of Quatech boards vs. non-compliant PCI boards.

Plug and Play

Implementing PCI control registers is vitally important to ensuring that **Plug and Play**, one of PCI's most attractive features, works properly. Setting jumpers and switches to configure address and IRQ is not required. The system configures itself by having the PCI BIOS access configuration registers on each add-in board at boot-up time. As these configuration registers tell the system what resources they need, (I/O space, memory space, interrupts, etc.), the system can allocate its resources accordingly, making sure that no two devices conflict.

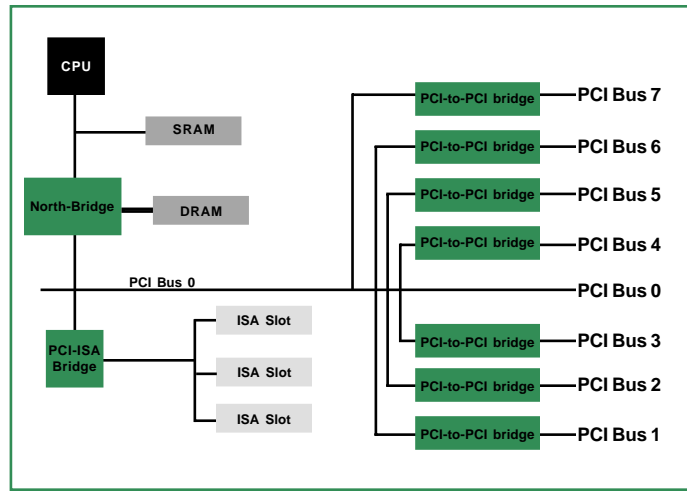

(PCI Bus System with 8 PCI Buses and a PCI-ISA Bridge)

While this method is ideal for an exclusively PCI system, it does pose problems for systems using both ISA and PCI, because PCI BIOS cannot directly query ISA devices to determine which resources they need. Using a PCI-ISA bridge (see diagram above) to enable communication can help.

Another implication of the PCI implementation is that a board's I/O address and interrupt are not fixed, meaning that they can change every time the system boots. Consequently, application software written for ISA boards, which are hard-wired to particular interrupts, will not directly transfer to PCI-based systems. This is a serious consideration when contemplating switching to PCI.

The High Speed, Wide Bandwidth Advantage

More than any other bus, PCI can take full advantage of today's high-power microprocessors to deliver extremely high speed data transfers. The original PCI bus was designed to operate with a 33MHz clock, to provide data transfer speeds up to 132 Mbytes/sec. These 32-bit adapters can use multiplexing to achieve 64-bit data transfers. (Later versions of PCI enable true 64-bit data transfers using up to a 133MHz clock to enable transfer speeds of up to 1066 Mbytes/sec.) These boards use a longer connector that adds an additional 32-bits of data signals. This is done by using the same set of pins to address and send data, the former implemented on the first clock cycle and the latter on the second. PCI's **burst mode** facilitates this operation as it allows a single address cycle to be followed by multiple data cycles. A special bus signal called a **Cycle Frame** is used to signal the beginning and end of a transfer cycle. Parity signals are used to ensure signal integrity, which is particularly vulnerable in such a complex transfer system.

The high speed data transfers across the PCI bus limits the number of PCI expansion slots that can be built into a single bus to 3 or 4, as opposed to the 6 or 7 available on the ISA bus. To expand the number of available expansion slots, PCI-to-PCI bridges are used. (See diagram left.) These bridges create a primary and a secondary PCI bus, each of which is electrically isolated from the other. Multiple bridges can be cascaded, theoretically allowing unlimited numbers of PCI slots to be configured in a single system. (Practically, it is important not to overload the CPU, as adding too many devices via expansion slots could considerably compromise system bandwidth.) The bridge enables bus transfers to be forwarded upstream or downstream, from one bus to another until the target/destination is reached.

Flexible Bus Mastering

Several pins on the PCI bus are reserved for implementing bus mastering. This means that any PCI device can take control of the bus at any time, even allowing it to shut out the CPU. Devices use bandwidth as available, and can potentially use all bandwidth in the system if no other demands are made for it. Bus mastering works by sending **Request** signals to the **Central Resource** (circuitry on the motherboard shared by all bus devices) when a device wants control of the bus, and when that control is ceded a **Grant** signal is received by the device. This flexible approach, which separates the arbitration and control signals (they were bussed together on MicroChannel and ISA), allows a computer designer greater control over the arbitration process.

Interrupt sharing on the PCI bus is also implemented to provide maximum flexibility. Four level-sensitive interrupts are located on the bus at pins A6, B7, A7 and B8, each of which can be assigned to from one to 16 separate devices. These interrupts can be activated at any time because they are not synchronized with the other signals on the bus. The PCI specification does not define how interrupts are to be shared. The process is implemented on a case-by-case basis by the motherboard manufacturer. For instance, Quatech multi-port serial PCI boards require only one slot to provide up to eight serial ports. These eight ports share a single interrupt, and our boards provide an interrupt status register that will indicate which of the eight ports triggered an interrupt.

Looking Ahead

The PCI-X specification is a high-performance enhancement to the PCI bus specification. It doubles the maximum clock frequency that can be used by PCI devices from 66 MHz to 133MHz, thus enabling communication at speeds over 1 Gbyte/sec. It also improves the efficiency of the PCI bus itself and the devices attached to it, by providing new features such as split transactions and transaction byte counts. PCI-X was developed for applications such as Gigabit Ethernet, Fibre Channel and other Enterprise server applications.

PCI Specification 3.0 is due for release in late 2001. This specification is largely based on PCI-X, and is intended to solidify the extensive changes made to PCI since the release of Specification 2.1. It also addresses a number of power issues designed to make PCI systems more efficient.

Clearly, traditional PCI add-in boards are not practical for portable systems or for systems that use small-size cases. Two new standards have been developed that address these issues: **Low Profile PCI** and **Mini-PCI**. Low Profile PCI was designed to provide greater flexibility in desktop and server environments. The card is mechanically similar to a standard PCI card, but uses a shorter card and a different mounting bracket. (See the figure below).

Low Profile PCI cards are designed to fit into systems as low as

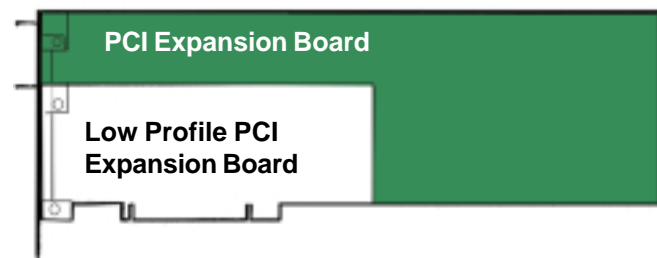

(Relative sizes for PCI and Low Profile PCI boards)

COM

Continued on page 18

Quatech guide to choosing a quality PCI communication board

The PCI bus specification was designed to take the guesswork out of choosing and installing add-in boards. Unlike the ISA bus, where each board had to be jumper configured by hand, then incorporated into an existing system at a specific address and IRQ that did not conflict with anything else installed in that system, the PCI bus was supposed to let the system itself take care of everything. By developing a strict set of hardware and software parameters, the architects of PCI mapped out a system by which PCI cards could be allocated resources by the BIOS. This way the BIOS itself could solve and resolve any addressing or interrupt conflicts occurring as a result of multiple PCI boards coexisting with each other and with other system devices--without user intervention. However, a PCI system is only as strong as its weakest link. In order for the system to consistently function properly, all installed PCI boards must completely adhere to all aspects of the PCI specification, and in a perfect world they would. But, complete adherence to the exacting PCI specification not only requires extensive engineering expertise, it also requires the purchase of top-quality components and meticulous board design and manufacturing.

Quatech has been manufacturing communication boards for over 18 years, so we have the expertise to do it right. We are also committed to providing only top-quality boards and to investing the necessary resources to ensure that every Quatech PCI board complies with all aspects of the PCI specification as closely as possible. Unfortunately, not all companies have the same high standards we do. Therefore, users need to remember that just because a board is calling itself "PCI" and fits into a computer's PCI slot, that does not mean that it correctly implements the PCI specification. While a non-compliant PCI board may seem to work when it is first installed, it might cause problems when combined with other PCI boards (especially other non-compliant boards), or when moved to a different motherboard, or when the PCI bus is heavily stressed. Is that really a chance you are willing to take with your system?

We know that Quatech boards aren't your only choice, but we truly believe that there aren't any better ones. The chart below details the important PCI specification compliance issues to keep in mind when evaluating PCI boards. The following page highlights the design elements you should look for in a quality PCI board, and shows what is missing in a non-compliant one.

Compliance Issue	Importance	Quatech Boards	Other Manufacturers
All unused 5V and 3.3V power pins are plated on the connector (goldfingers)	Better data integrity because high-speed PCI signals use the power pins for return paths	YES!	Sometimes, often omitted when "cutting corners"
All 3.3V power pins are decoupled from ground with capacitors	Better data integrity because high-speed PCI signals use the power pins for return paths	YES!	Rare, ground return path capacitors are often omitted
All PCI signal lines have one and only one load (connected to only one pin on one component on the board)	Better data integrity because the PCI bus is extremely sensitive to signal loading	YES!	Usually, but sometimes violated
JTAG boundary scan chain intact if unused (connect TDI and TDO signals)	JTAG boundary scan systems can work with the board installed	YES!	Extremely rare
Trace length of 1.5" or less on PCI signals	PCI signals rely on specific travel times up and down the bus. Proper trace lengths ensure data integrity	YES!	Usually, but sometimes violated
PCI clock trace is 2.5" ±0.1" in length	PCI clock signal timing is particularly critical. All other PCI signals depend on accurate clock delivery	YES!	Often violated
Full PCI configuration space implemented	So that plug-and-play really works	YES!	Almost always, but there are some exceptions

Communication Overview

Look closely at the PCI card you are considering buying. Does it comply with all aspects of the PCI specification? Quatech boards do. Can you really afford the potential aggravation of using a non-compliant board in your system?

Do you see blank spaces on the edge connector instead of a complete row of gold-plated pins?



Notice the two tight rows of "gold fingers" on the Quatech board. This indicates that all PCI signals and power pins are plated, even those that are unused. The result is better data integrity because high-speed PCI signals use the power pins for return paths.

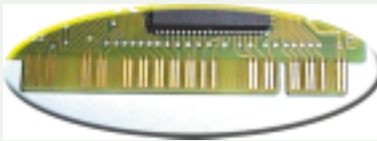

Notice the loosely spaced goldfingers and the large gaps on the non-compliant board. This indicates that not all pins are plated, and that data integrity may be compromised.

Do you see large "pools" or "grids" of ground signals running all over the board?

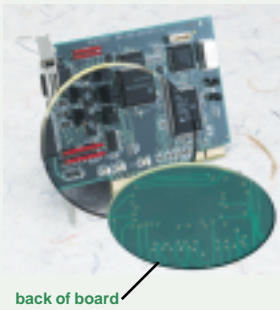

Notice that there are no grids apparent on the surface of the Quatech board. This is because all Quatech boards have a four-layer board design using separate layers for power, ground and signals thus reducing noise and enhancing signal integrity.

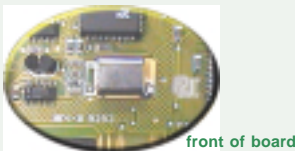

Notice the grids of ground signals on the front and back of the non-compliant board. This indicates the lack of a separate ground layer and complicates signal routing. This makes the board more susceptible to noise and can compromise signal integrity.



Is your board truly Plug and Play or do you see jumpers for setting basic configuration parameters such as address?



The Quatech board contains a controller chip in which all PCI configuration registers are properly implemented. This means that the PCI BIOS can use the information stored on the chip to automatically configure the Quatech board, making it truly Plug and Play.



The non-compliant board has no controller chip, and basic configuration settings such as address and IRQ must be selected manually via jumpers on the board. Not only is this board not Plug and Play, it has the potential to conflict with other PCI devices in the system.

Do you NOT see a row of tiny capacitors (usually rectangular) just above the edge connector on the front or back of the board?



Capacitors which connect the power signal to a ground are part of the PCI specification and are designed to filter out noise. As it is fully PCI compliant, the Quatech board includes these capacitors. The capacitors also promote signal integrity, as high-speed PCI signals use the power pins for return paths.



Notice that the non compliant board is missing the required capacitors. This omission makes the board particularly vulnerable to noise problems and loss of signal integrity in high-speed operations.

COM

PCI and CompactPCI

3.350" without using riser cards. There are two types of Low Profile PCI boards: MD1 and MD2. Both are built on 32-bit addressing, and differ only in length (MD1 being shorter than MD2.) Systems can be designed to support one or both configurations. Existing PCI backplanes used for standard cards can also accept the Low Profile cards. However, the Low Profile specification also includes a new bracket design that cannot be used with standard PCI boards.

Mini PCI, on the other hand, is not backward compatible with any older devices. It is designed to be used by system integrators to add additional functionality for mobile computers. It requires a completely new interface, and is typically used to add communication peripherals such as modems and network interface cards to notebook computers, docking stations, or sealed case PCs.

Mini PCI boards are even smaller than Low Profile boards, with a minimum size specification of 2.75" x 1.81" x 0.22." They are functionally equivalent to standard and Low Profile boards, using the same protocols, PC signals and software drivers. However, because of the small size they require higher density, more compact, and thus more expensive components. So, while Mini PCI is extremely useful for the mobile applications for which it was intended, it is not the most economical or flexible choice for desktop expansion.

PCI for Data Communication

PCI is fast becoming the de facto standard for board-level expansion slots in PC-based systems. However, for serial and parallel communication, the potential of PCI goes largely untapped. Limitations of these communication protocols considerably slow down the system. (See pages 25-28 for more on serial and parallel communication.) The PCI specification anticipates this situation, and the bus is designed to slow down when dealing with low speed devices. So, though running serial and parallel devices via a PCI bus will not cause system problems, neither will it significantly improve system performance over ISA. But, as ISA slots are fast becoming obsolete, you may have no choice but to use PCI add-in boards in newer systems. For higher speed devices such as audio, streaming video, interactive gaming, high-speed modems, etc., PCI provides a clear advantage over older bus architectures.

PCI competes with both USB (see page 22) and IEEE 1394 (see

page 24) for high-bandwidth applications. All three provide the advantage of **Plug and Play** installation, which may be important to some users. Currently, only USB and IEEE 1394 support **hot swapping**, but support for it is planned in a future PCI specification. USB has been positioned as a low cost solution for a variety of desktop applications. IEEE 1394 is used mainly for video applications. However, PCI still has a speed advantage when using true 64-bit data transfers. In fact, in many systems USB or IEEE 1394 ports are added to a system via the PCI Bus (see Quatech's TFC-100 page 69).

CompactPCI

PCI for Industrial Computers

CompactPCI is based on the electrical functionality of desktop PCI and the Eurocard physical form factor. It is designed for ruggedized applications in industrial environments. CompactPCI boards have several features that make them ideal for embedded systems or for industrial PCs:

- High density 2mm pin and socket connectors
- Designed for vertical card racks for better cooling
- Excellent vibration and shock protection characteristics
- Shield for EMI/RFI protection
- I/O connections on front or rear of module
- Staged power pins for hot swapping

Form Factor

The key to the CompactPCI bus is a gas-tight, high-density pin and socket connector that meets the IEC-1076 international standard (pictured below).



(CompactPCI 220 pin connector)

Its low inductance and controlled impedance make it ideal for PCI signaling. The connector uses a 2mm "Hard Metric" connector and has 47 rows of 5 pins per row, with a total of 220 pins (15 pins are used for the keying area). An additional external metal shield is also used. The large number of ground pins ensures adequate shielding and grounding for low ground bounce and reliable operation in noisy environments. By controlling impedance, the connector can minimize signal reflections.

Communication Overview

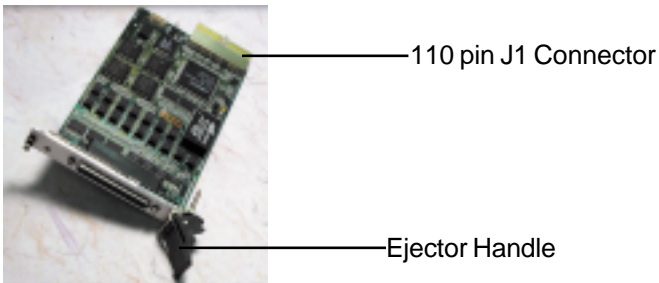

(Quatech QSCP-100, 3U CompactPCI board)

CompactPCI boards must follow one of two size specifications and have ejector handles that are IEEE 1101.10 compliant. 3U boards measure 100mm x 160mm, and 6U boards measure 233.53mm x 160mm. The 3U boards have a single ejector handle and use a 220 pin connector for all power, ground, and all 32- and 64-bit PCI signals. This connector consists of two halves – the lower half (110 pins) is called J1 and the upper half (also 110 pins) is called J2. Twenty pins are reserved for future use. 3U boards that only perform 32-bit transfers can use a single 110 pin connector (J1). For example, Quatech's QSCP-100 serial CompactPCI serial board (see page 70) is a 32-bit 3U board using a single J1 connector. Both 32-bit and 64-bit 3U boards can be mixed on a single CompactPCI backplane.

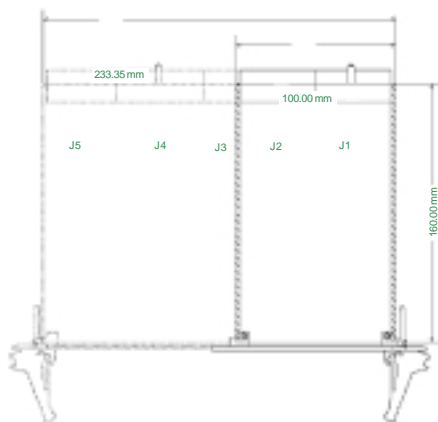

(CompactPCI form factors for 3U and 6U boards)

6U boards can have up to three additional connectors (J3-J5) with a total of 315 2mm style pins, and because of their large size use two ejector handles. The CompactPCI specification only defines signal-pin assignments for J1 and J2. J-3 through 5 can be user defined based on application requirements. They can also be used as a bridge to other buses like VME or ISA in hybrid backplanes. PICMG is developing future specifications for a standardized use of the additional connectors.

CompactPCI Systems

The CompactPCI system is made up of CompactPCI bus segments, each of which has one system slot and up to seven slots for CompactPCI peripherals (at 33MHz). The system slot is used to control the peripherals attached to the bus segment. For example, it provides bus arbitration, clocking, and reset functions, as well as system initialization functions. It can be located at any position in the backplane, and must use both J1 and J2 to control both 32-bit and 64-bit peripheral boards. The peripherals in the remaining seven slots can be simple boards, intelligent slaves or PCI bus masters. By using PCI-PCI bridge chips, the CompactPCI bus can be expanded in 8 slot increments.

Peripherals attached to the first four PCI connectors are provided a unique PCI interrupt. After that, rotating interrupts are assigned to allow boards to share interrupts. The System Slot board always has its own interrupt. Rules for interrupt sharing are derived from the specification governing PCI bridges. Note that because some devices require more than one interrupt, interrupt sharing may be required even if only the first four slots are used.

COM

CompactPCI is designed to use both +5V, and +3.3V devices. +V(I/O) power pins are designed for universal boards that can operate at either +5V or +3.3V. A keying technology is used to prevent a board from being attached to the wrong power pins. Universal boards are not keyed. Backplanes have both +5V and +3.3V, and, depending on the application, Universal boards can use either. Typically, for 5V operation a brilliant blue coding plug is used on the backplane, for 3.3 V operation a Cadmium yellow coding plug is used. Power terminals can be located on the front, rear or side of the backplane.

CompactPCI for Data Communication

CompactPCI boards are designed for ruggedized, industrial environments. They are also ideal for many embedded systems that are implemented in such environments. Though they are electrically similar to standard PCI boards, CompactPCI boards cannot be used in a desktop computer without a special adapter board. They are made to be used in specialized enclosures designed to provide both superior protection against environmental hazards and easy access for rewiring, replacing, or exchanging peripherals. To that end the pin sequence on the backplane connector is staged to support hot swapping.

Quatech serial PCI boards with the "IND" option are also designed for use in industrial environments. However, to implement protection on the board itself requires sacrificing speed. The CompactPCI specification is specifically designed for such environments, and can optimally implement data communication peripherals in them.

PCMCIA

PCMCIA

Expanding Portable Systems

Founded in 1990, the Personal Computer Memory Card International Association (PCMCIA), of which Quatech is a member, developed a set of standards by which additional memory could be added to portable systems. It soon became apparent that this same interface could be used to add I/O devices and hard disk drives as well, thereby dramatically increasing functionality of laptop computers. Today, just about any device available for desktop computers using an ISA or PCI bus is also available with a "PC-Card" interface for use with laptop computers, and in some cases, hand-held machines.

Physical Characteristics

The PCMCIA specification 2.0 release in 1991 added protocols for I/O devices and hard disks. The 2.1 release in 1993 refined these specifications and is the standard around which most PCMCIA cards are built today.

PCMCIA cards are credit card size adapters which fit into PCMCIA slots found in most hand-held and laptop computers. In order to fit into these small size drives, PCMCIA cards must meet very strict physical requirements as shown in the chart below. There are three types of PCMCIA cards, Type I generally used for memory cards such as FLASH and STATIC RAM; Type II used for I/O peripherals such as serial adapters, parallel adapters, and fax-modems (this is the type of card Quatech manufactures); and Type III which are typically used for rotating media such as hard disks. The only difference in the physical specification for these cards is thickness.

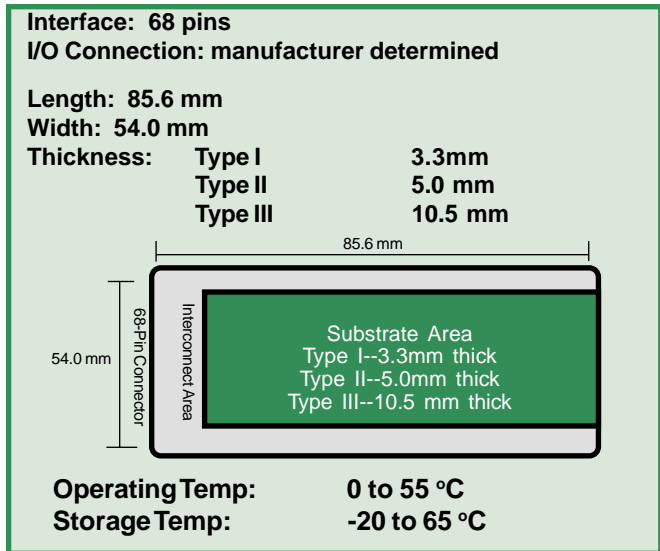

(PCMCIA Card Physical Characteristics)

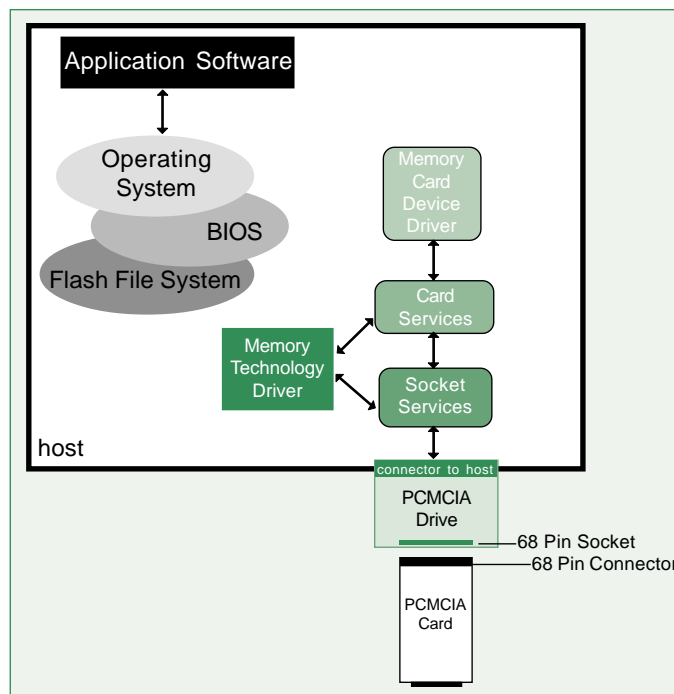

(Block Diagram of a Basic PCMCIA Expansion System)

Card & Socket Services

Functionally, a PCMCIA card can perform any memory or I/O operation as long as it adheres to the PCMCIA interface structure. As shown in the above diagram, PCMCIA is a tiered system that uses a set of device independent drivers to integrate any type of PCMCIA card into the host system. Socket Services, the lowest tier in the architecture, provides a universal software interface for the PCMCIA sockets themselves. Socket Services manages all the sockets installed in a system so that resources can be properly allocated. It is also the means by which individual cards access registers on the host system. Socket Services can be added to a computer as a device driver, or it can be built into the PC BIOS.

Directly above Socket Services in the hierarchy sits Card Services. Card Services is an application programming interface (API) that permits multiple software programs to work with multiple PCMCIA cards. For instance, Card Services will allow both internet applications and fax applications to use an installed PCMCIA card modem. Like Socket Services, Card Services can be implemented as a device driver, and can be built into a computer's operating system, as it is in Windows 95/98/Me/NT/2000 and OS/2.

16-Bit PCMCIA

PCMCIA specification 2.1 provides for a 16-bit bus interface, has a maximum clock speed of 10MHz and is capable of speeds to

Communication Overview

20Mbps. The 2.1 spec. does not provide for bus mastering, DMA, or multiple interrupts, (however, Quatech's interrupt sharing software drivers allow sharing the one interrupt among multiple I/O devices). While PCMCIA provides only a minimal performance improvement over ISA, and does not come close in speed to PCI, it does provide for considerably more flexibility than either of the others.

The two most important features of PCMCIA are its Plug and Play and Hot Swapping capabilities. As with PCI, PCMCIA cards are truly Plug and Play--you simply insert them, and instructions coded into chips on the card provide the information a host needs to configure the cards and appropriately allocate resources. Not only are there no jumpers or switches to set, users never even see the inside of a PCMCIA card. It is simply inserted into the drive, and the system does the rest. (An open PCMCIA card is pictured below, to show what you've been missing.)

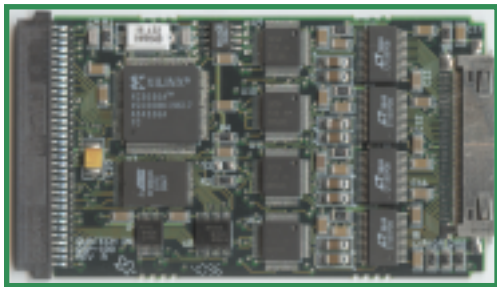

(Quatech's QSP-100 PCMCIA Card Uncovered)

This configuration procedure, along with the fact that PCMCIA cards are not connected directly to the motherboard, but are easily inserted into and ejected from a PCMCIA drive, allows the cards to be hot swappable. This means that the system need not be shut down then re-booted to add, remove, or exchange cards. Thus, you could insert a PCMCIA scanner, scan a drawing of your newest board layout, then remove the scanner and insert a modem and e-mail the scan to a manufacturer for mass production. While this might not be very important for desktop PCs with large numbers of expansion slots, it is vitally important for laptops with limited resources and usually only two PCMCIA slots. It becomes even more important for hand-held computers which often have only one PCMCIA slot and one serial port.

32-Bit CardBus

In 1995 the PCMCIA 2.1 specification was enhanced to provide for 32-bit operation. The new architecture, called *CardBus*, was closely based on the PCI bus, and strove to provide the same improvements over the 16-bit PCMCIA card as PCI did over ISA. As such, *CardBus* provides for 33MHz operation and correspondingly increased data transfer. It also introduces DMA

and bus mastering to PCMCIA based systems, which can markedly increase performance. Realizing that there are still many 16-bit PCMCIA card peripherals in the marketplace CardBus is fully backward compatible with the older card design.

Because of this backward compatibility, Quatech has decided not to redesign our serial data communication PCMCIA cards for CardBus, as doing so would limit the number of systems that could use our cards. As discussed with PCI, because of the limitations imposed by serial and parallel transfers, there would be no noticeable performance gains for Quatech serial cards under CardBus. However, our new DFP-100 two port IEEE1394 card, (see page 57 for card specifications and page 24 for more on IEEE 1394) does use the CardBus interface. IEEE 1394 peripherals can communicate at speeds up to 400 Mbits/sec, and thus can take advantage of the higher speed communication CardBus provides.

PCMCIA for Data Communication

Though PCMCIA card use is not limited to portable computers, (see pages 58-60 for PCMCIA drives for desktop PCs) there are few instances where it is the best choice for data communication in desktop computers. In desktops, PCMCIA is better suited for adding extra storage space via hard-disk cards, or transferring large files from portable systems. However, for laptop and hand-held computers, PCMCIA provides a way to connect a varied array of peripherals to the system, and to share those devices with a desktop computer.

Clearly there is a size advantage to PCMCIA for portable applications. The cards are small, light, and have low power requirements. They are an ideal interface choice for peripherals that have been scaled down for portable use. Further, the ability to Hot Swap PCMCIA cards provides for the flexibility needed to use multiple peripherals with only one or two slots. USB and IEEE 1394, which also provide Hot Swapping, (see pages 22-24), are other alternatives for portable applications. IEEE 1394 uses a particularly small cable ideal for portable applications, and is ideal for high speed audio and video applications. However, to use USB or IEEE 1394, the peripheral devices in your system must be replaced with bus specific devices--an expensive prospect. Further, many USB products must be powered by the computer itself, thereby reducing the time a laptop can function on battery alone. Or, if too much power is required, they must be plugged-in, making them less attractive portable solutions. So if cost and power conservation are your primary concerns, PCMCIA is still the best, most flexible choice for portable applications.

COM

USB

The User-Friendly Choice

The Universal Serial Bus (USB) was developed around the idea that users should be able to run multiple peripherals on their computers without the hassle of physically installing boards, manually allocating system resources, individually configuring devices, and powering the computer up and down every time equipment needs change. With USB, up to 127 individual peripheral devices can be connected to a host computer using a single interface and a system of USB hubs. (See right for a diagram of a typical USB system.) Attaching a USB peripheral to your computer is as easy as plugging headphones into your Walkman. USB devices are automatically recognized and configured. They can draw power directly from the system, from an attached self-powered hub, or be connected to their own power supply.

USB Features

USB provides two-way communication between the PC and peripheral devices, making it ideal for many I/O applications. Multiple devices can connect to a system using a series of USB hubs and repeaters. A single USB interface is attached to the motherboard. A Root Hub with up to seven additional ports can be integrated into the main interface, or it can be externally connected with a cable. Each of the seven hubs on the Root Hub can in turn be connected to seven hubs, etc. to a maximum of seven tiers and 127 ports. A unique feature of USB is that a peripheral device can have a hub built into it. This type of peripheral, called "compound devices," are comprised of a function device and one or more hubs. For example, a USB keyboard can contain an additional USB port for a USB mouse.

USB is generally described as having a tiered star topology, however each device communicates with the host as if it had its own connection. This means that communication from the host centers around a set of hubs/devices, each of which in-turn serves as the center for another set of hubs/devices, etc. However, the hubs are transparent to the software and the devices are addressed individually. Cables are used to create point-to-point connections between devices and USB ports, or to connect one USB hub to another. The maximum cable length is five meters long. However, a repeater hub may be used to extend the distance between the peripheral and the host. There are also special USB repeaters that can be used to extend the connection even further. (See page 92 for Quatech's QExtend-4)

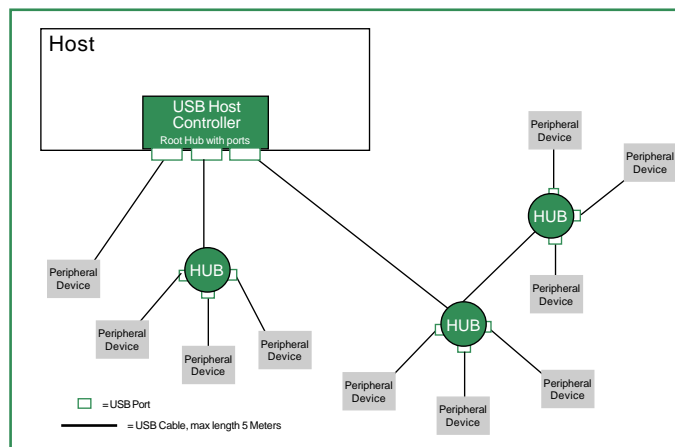

(A Typical USB System)

Operating System support for USB is built into later releases of Windows 98 and the new Windows 2000. You can find out whether your system supports USB by downloading an USB evaluation utility from the official USB website (www.usb.org).

The USB Difference

USB is technically not a bus in the tradition of ISA, MCA or PCI, as it provides more than a simple interface to the host computer. Nor is it merely a communication protocol along the lines of serial and parallel communication which are dependent upon an external interface to reach the host computer. USB combines the bus and the communication protocol into a single entity which connects directly to a peripheral device. (Review the diagram on page 11 for a better understanding of this difference.) As such, the USB standard encompasses both the interface and the method of communication. Whereas, in a PCI-based system one standard defines the bus (eg. PCI Specification 2.1) and another defines the communication protocol (eg. RS-232).

Cables and Ports

The Root USB Hub is connected directly to the USB Host, and from there everything is done with cables. Two types of cables can be used with USB devices: Series A and Series B. Series B cables are limited to 3 meters in length and are for use with low-speed (1.5 Mbps) USB peripherals such as keyboards and mice. The UTP cable has a pair of 28 AWG wire stranded copper for data and one pair 20-28 AWG for power.

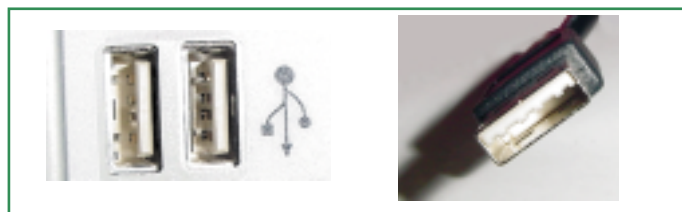

(Series A USB Port (left) and USB Connector (right))

Communication Overview

The Series A connector pictured (see bottom left) is for use with high speed (12 Mbps) devices, and can be up to 5 meters long. The more common of the two, it consists of one pair 20-28 AWG wire for power (V_{BUS} is typically +5V at the source) and one 28 AWG twisted wire pair for data. The connector has a shielded housing, making it STP compliant. (See the drawing of a USB cable below.)

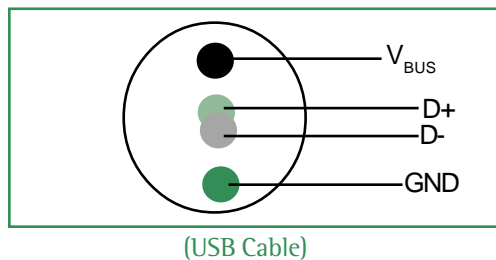

(USB Cable)

Power Management

One special feature of USB systems is that they can directly supply power to the peripherals and the hubs attached to them. It can also regulate power usage for peripherals that use independent power sources. USB devices are classified based on the amount of power they supply or require. Low Bus Power devices take all their power from the bus, but no more than 100mA at a time. High bus-powered devices also take all their power from the bus, but can draw up to 500mA at a time. Self-powered devices use an external power supply, but can draw up to 1mA from the host if necessary--such as in the case of a power failure.

Hubs can also be low, high or self powered. Power flows downstream in a USB system, which means that a self-powered hub can be used to power high- and low-powered peripheral devices located further down in the network. This power arrangement has both advantages and disadvantages. For desktop systems where power is not a problem, it is extremely convenient not to have to use a separate outlet for each peripheral connected to the PC. In notebooks where battery longevity is often a problem, it might be more advantageous to use peripheral devices that have their own power source.

Looking Ahead

USB Specification 1.1 was designed for low to medium speed applications running at less than 12 Mbits/sec. As such it is not suited for high-end data transfer such as high-speed back-ups to hard disks or CDs, high resolution color printing and interactive gaming. The recently released USB Specification 2.0 aims to upgrade the bus for high performance applications. The main difference between Specification 1.1 and 2.0 is that the latter provides for data transfer rates up to 480 kbits/sec.

USB 2.0 is fully backward compatible with all older USB devices. It merely adds another device class--"high speed device." The USB host controller determines the type of devices attached to it, and then treats them accordingly. In fact, a high-speed USB hub can be used for both high, full (12Mbps) and low (1.5Mbps) speed devices at the same time.

While still relatively new, many manufactures are starting to release 2.0 peripherals. Quatech's serial USB adapters will remain USB 1.1 devices, as even the fastest serial communication is limited to 10Mbps--well within the range of a full speed device.

USB for Data Communication

For low to medium speed data communication applications USB Specification 1.1 provides a clear usability advantage older bus types. USB peripherals are both Plug and Play and Hot Swappable devices. Further, USB is flexible enough to incorporate up to 127 individual devices into a single system using only one interface. And, unlike PCMCIA cards, where the board itself is subject to considerable wear from multiple insertions and extractions, USB devices use a connector cable which can be inserted and removed multiple times without consequence. Because of USB's structure, it can potentially reduce system downtime considerably.

As a bus option designed for both desktop and portable use, USB can bridge the gap between desktop and portable peripherals, provided the new peripherals are designed in small enough form to be practical for portable systems, and provided they do not draw too heavily from a laptop's limited battery power.

USB 2.0 with its considerably higher speeds will rival both board-level interfaces such as PCI and other interfaces such as IEEE 1394 (see next page). In fact, some computer companies are pushing for a PC standard that will no longer supply slots for plug-in boards, and will rely completely on USB and IEEE 1394 type devices. With the knowledge that IEEE 1394 has become the standard for video applications, USB 2.0 has been positioned as a more general purpose, and low-cost, solution.

USB's major drawback, one it shares with IEEE 1394, is its inability to implement peripherals designed for older protocols. As USB popularity increases, it is becoming more likely that a USB device exists for any given application. However, software applications written for non-USB peripherals cannot be implemented using USB because of the difference in communication protocols. Quatech has solved this problem with our FreedomUSB serial adapters (see pages 86-93). With Quatech's FreedomUSB Series you can take full advantage of USB benefits while continuing to use your current serial peripherals in your existing applications.

COM

IEEE 1394

IEEE 1394

The High-Speed Multimedia Solution

IEEE 1394 is a high-performance serial bus designed for high speed audio, video and data transfer applications. First introduced by Apple Computer as "Firewire" in 1986, the standard is now overseen by the Institute of Electrical and Electronics Engineers (IEEE). This same standard is also referred to as "i.LINK" by Sony Corporation which has trademarked that name.

Unlike the other wired busses described so far, IEEE 1394 is unique in that it does not require a PC in order to function. For example, IEEE 1394 can be used to send a picture directly from a digital camera to a printer, or to transfer a file between two digital video cameras. Another outstanding feature is that IEEE 1394 does not require that digital data be converted to analog. Thus, provided that a network is comprised of exclusively digital devices, using IEEE 1394 can considerably improve and maintain signal integrity--even over multiple transfers of the same data. Other advantageous IEEE 1394 features are Plug and Play and Hot Swap capability, and the very small cable size that is ideal for portable devices.

The first IEEE 1394 standard was designed for PC backplanes and supported data rates of up to 50 Mbits/sec. IEEE 1394a was approved in 2000, and supports speeds of 100 Mbits/sec, 200 Mbits/sec and 400 Mbits/sec. 1394a, which was designed to use a cable interface, also provides improved traffic control and added power management features. To increase speeds even further, a new specification, IEEE 1394b, is scheduled to be released in late 2001. The new standard is supposed to increase IEEE 1394 bandwidth as high as 3.2 Gbits/sec.

The IEEE 1394 System

IEEE 1394 systems can connect up to 63 devices together via a single bus connection which may or may not include a computer. They can be connected in either a star or tree pattern, and multiple devices can be daisy chained off any branch. Addressing for these devices is done dynamically each time the system is powered up, or when a device is added or removed from the network. For even larger networks, multiple 1394 busses (up to 1,203 busses) can be bridged together.

Both asynchronous (see page 25) and isochronous (see page 28) communication are supported under IEEE 1394. Asynchronous communication is used for applications such as writing data to disk, and employs the extensive error-checking necessary to safeguard signal integrity. However, such error checking requires a delay that makes asynchronous communication impractical for time sensitive applications such

as streaming video. Isochronous transfers, which guarantee a steady transfer rate but do not provide any error checking, are used for such applications. The IEEE 1394 bus reserves space for both types of transfer to occur in the same network, at the same time if necessary. The IEEE 1394 network can also support multiple devices operating at different data rates simultaneously.

IEEE 1394 Cabling

The IEEE 1394 standard includes two cable specifications. The difference between the two is that the 6-pin connector includes power and ground pins, allowing one 1394 device to provide power (up to 60 watts) to others in the network. The 4-pin connector lacks these power pins, and thus 4-pin devices must provide their own power. The advantage to the 4-pin connector is size--the 4-pin (at 5mm x 3mm) is considerably smaller than the 6-pin (at 10mm x 5mm), and thus better suited for portable applications. The maximum cable length for high speed applications (greater than 200 Mbits/sec) is 4.5 meters. However, at slower speeds, cables up to 14 meters long can be used. Multiple devices can also be daisy-chained using repeaters to extend communication distance.

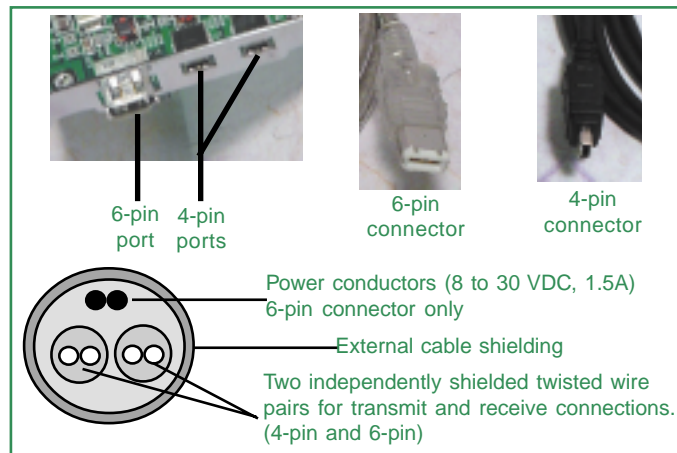

(IEEE 1394 4-pin and 6-pin connectors)

IEEE 1394 for Data Communication

IEEE 1394 has become the standard for high-speed video applications. In fact, typical video controls such as play and rewind have been written into the specifications. 1394 support is included in Windows 98/Me/2000, making it a good solution for various high-bandwidth PC-based applications such as data transfers to external hard disks or video editing. It shares many of the same features as USB (see page 22), though it is significantly faster than USB 1.1. USB 2.0 comes close to matching speed, however most people find the busses complimentary. USB is a more general standard geared towards desktop peripherals, and it requires a computer. IEEE 1394 has targeted the multimedia audio/video market, and it also provides the advantage of allowing compliant devices to communicate without a PC.

SERIAL COMMUNICATION

Asynchronous

The Simple, Inexpensive Choice

Most PC serial devices such as mice, keyboards and modems are asynchronous. Asynchronous communication requires nothing more than a transmitter, a receiver and a wire. It is thus the simplest of serial communication protocols, and the least expensive to implement. As the name implies, asynchronous communication is performed between two (or more) devices which operate on independent clocks. Therefore, even if the two clocks agree for a time, there is no guarantee that they will continue to agree over extended periods, and thus there is no guarantee that when point A begins transmitting, point B will begin receiving, or that Point B will continue to sample at the rate Point A transmits. See the diagram below for an illustration of what happens when transmission clocks differ significantly.

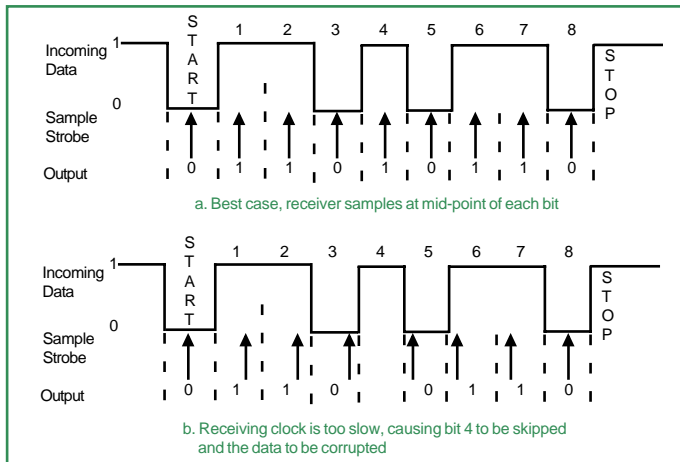

(Ideal and corrupted asynchronous data sampling)

To combat this timing problem, asynchronous communication requires additional bits to be added around actual data in order to maintain signal integrity. Asynchronously transmitted data is preceded with a *start bit* which indicates to the receiver that a word (a chunk of data broken up into individual bits) is about to begin. To avoid confusion with other bits, the *start bit* is twice the size of any other bit in the transmission. The end of a word is followed by a *stop bit*, which tells the receiver that the word has come to an end, that it should begin looking for the next *start bit*, and that any bits it receives before getting the *start bit* should be ignored. To ensure data integrity, a *parity bit* is often added between the last bit of data and the *stop bit*. The *parity bit* makes sure that the data received is composed of the same number of bits in the same order in which they were sent. See the diagram (above right) for a portrayal of how asynchronous communication works.

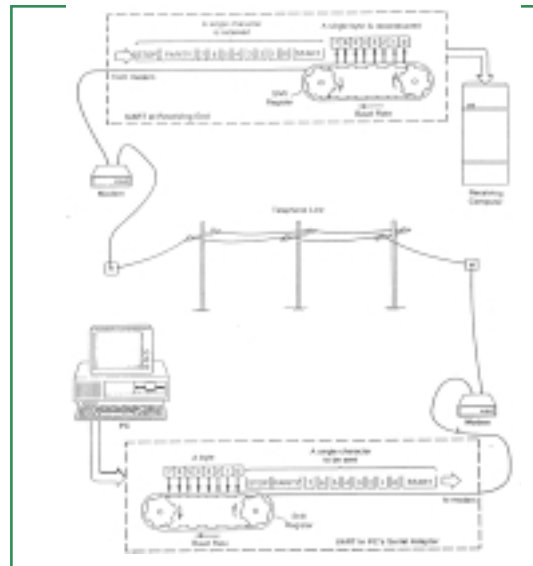

(Asynchronous Serial Communication System Model)

Upgraded UARTs For Increased Performance

At the heart of every asynchronous serial system is the Universal Asynchronous Receiver/Transmitter or UART. The UART is responsible for implementing the asynchronous communication process described above as both a transmitter and a receiver (both encoding and decoding data frames). The UART not only controls the transfer of data, but the speed at which communication takes place. However, the first UARTs could only handle one byte of information at a time, which meant that the computer needed to immediately process any transmission or risk losing data as the next byte of information pushed its way onto the UART. Not only does this makes for unreliable and slow communication, it can slow down the entire system.

Improved UARTs, such as the 16750 UARTs, increase communication speed and lower system overhead by offering 64-byte FIFOs (first in first out buffers). With the 64-byte FIFO buffer, the UART can store enough information that the data stream need not be suspended while the computer is busy. This is particularly helpful in heavy multi-tasking operating systems such as Windows 95/98/Me/NT/2000 and OS/2.

Enhanced Serial Adapters for Even More Speed

Even with 16750 UARTs, serial boards with a standard 1.8432 MHz clock can only reach speeds of 115.2 kbits/sec. This is because the UART sets the baud rate by dividing down the clock frequency, and the lower the clock speed, the lower the possible data rate. The standard clock on Quatech serial boards can be multiplied by a factor of one, two, four, or eight by using jumper or software controls. High baud rates, up to 921.6 kbits/sec, can be produced through a combination of changing the clock rate multiplier and the UART baud rate divisor.

COM

Synchronous Communication

Synchronous

Coordinated Speed

As its name implies, synchronous communication takes place between a transmitter and a receiver operating on synchronized clocks. In a synchronous system, the communication partners have a short conversation before data exchange begins. In this conversation, they align their clocks and agree upon the parameters of the data transfer, including the time interval between bits of data. Any data that falls outside these parameters will be assumed to be either in error or a placeholder used to maintain synchronization. (Synchronous lines must remain constantly active in order to maintain synchronization, thus the need for placeholders between valid data.) Once each side knows what to expect of the other, and knows how to indicate to the other whether what was expected was received, then communication of any length can commence.

The theory behind asynchronous and synchronous communication is essentially the same: Point B needs to know when a transmission from Point A begins, when it ends, and if it was processed correctly. However, the difference lies in how the transmission is broken down. Think of the difference in terms of a friendly chat. With asynchronous communication you would need to stop after every word to make sure the listener understood your meaning, and knew that you were about to speak the next word. With synchronous communication, you would establish with your listener that you were speaking English, that you will be speaking words at measured intervals, and that you would utter a complete sentence, or paragraph, or extended soliloquy, before pausing to confirm understanding. Further, you would establish with your listener beforehand that any extraneous noises you make during the speech or between speeches (coughing, burping, hiccupping) should be ignored. Clearly the second approach is much faster, even though initializing communication may take slightly longer. In fact, by replacing the start, stop and parity bits around individual words with start, stop and control (processing instructions and error checking) sequences around large continuous data blocks, synchronous communication is about 30% faster than asynchronous communication, before any other factors are considered.

Clock Synchronization

In order to initiate a successful synchronous communication link, several distinct pieces of hardware must be configured around a common clock. This configuration must take two data lines into account, the transmission line (the line it uses to send data) and the reception line (the line it uses to receive data). It is essential

not only that all devices in the system be synchronized with each other, but also that each individual device have its transmission and reception lines synchronized as well.

There are three clocking methods by which to achieve synchronization: internal, external, and recovered clocking. All three methods derive the clock signal for the reception line from the incoming data. The clock signal for the transmission line will always be generated by the device's internal oscillator, but the phase reference used by the internal oscillator differs for each of the clocking methods. When internal clocking is used, the transmit clock is phase locked to the device's own internal oscillator. For external clocking, the transmit clock is phase locked to the phase of the oscillator belonging to another device in the network. For recovered clocking, the transmit clock phase is locked to the clock derived from the incoming data.

In general, the DCE device (such as a modem) uses internal clocking, while the DTE device (such as a PC) uses external clocking and synchronizes around the DCE device. (See page 30 for a detailed description of DTE and DCE devices.) In cases where DTE-DTE or DCE-DCE connections are necessary, one device must be configured atypically, or a device such as a modem-eliminator or tail-circuit buffer must be placed between the two. However, in large networks with multiple devices this is not always possible. One solution for such networks is to have all devices synchronize around a single modem's clock source. However, this solution has the tendency to result in clock drift, and thus can potentially corrupt data. The other solution is to use recovered clocking so that a modem can derive the clock from data on its reception line then send that information out on its transmit line to be used by the next modem in line, etc.

Byte-Oriented Synchronous Protocols

Synchronous communication can be implemented for full and half-duplex networks using bit- or byte-oriented protocols. Half-duplex networks, whether point-to-point or multipoint, can only support communication in one direction at a time. The most commonly used protocol for such networks is IBM's Binary Synchronous Communication Procedures (BiSync). BiSync is a byte oriented protocol, which means that it approaches transmitted data as "blocks" that must each be decoded and tracked to determine what they are, and what they are telling the receiver to do.

In a BiSync system one computer is designated as a control station. It is responsible for initiating all data transfers, and thereby controlling the direction of flow on the communication line. Byte-oriented communication begins with establishing synchronization,

Communication Overview

it then establishes communication parameters that define instructions for processing given bit sequences. Finally, the actual data will be transmitted, and then followed by several frames that validate the transmission. BiSync transmission is also governed by a strict set of rules for data transmission. These rules require frequent handshaking and validation--speaking in sentences rather than paragraphs between pauses. As a result of the extensive handshaking, and because communication can take place in only one direction, BiSync communication is best suited for low-speed applications.

Bit-Oriented Synchronous Protocols

In bit-oriented protocols, data is accepted as a long string of bits whose order does not impart specific instructions to the receiver. Data is flagged by a set bit pattern at either end, and is validated by a single frame check sequence at the end of the message that either accepts it or demands retransmission. Any bits received outside of valid flag sequences are ignored as placeholders.

Clearly, bit-oriented communication requires considerably less overhead than byte-oriented communication, because it is not constantly attempting to match bit sequences to numerous predetermined arrangements. The only sequence the bit-oriented protocol is concerned with identifying is the flag sequence. Bit protocols have other advantages over byte protocols as well. In a byte-oriented system, because of the constant handshaking, communication can take place in only one direction at a time. In bit-oriented systems, both ends can talk to each other at once, enabling effective use of full-duplex networks. Further, a single master device using bit protocols can communicate with multiple slave devices by using an **address field** following the start of **message flag**. This address field is tailored to each individual slave, and slaves only process data that is specifically addressed to them. Likewise, when the master receives from the slave, it knows from precisely where the transmission originated.

The two main bit-oriented protocols used today are Synchronous Data Link Control (SDLC) and High-Level Data Link Control (HDLC). SDLC, which was developed by IBM in the 1970s, is based around a network of primary and secondary network nodes. The primary controls the network and continually polls the secondaries to determine whether they have data to transmit. Four configurations are available for SDLC networks:

- Point to Point:** one primary connected to one secondary
- Multipoint:** one primary connected to multiple secondaries
- Loop:** one primary connects to the first and last secondary, and secondaries in the middle pass messages through each other to the primary.

Hub go-ahead: Uses one inbound and one outbound channel. The primary sends on the outbound channel and the secondaries send on the inbound channel. Secondaries pass messages through each other back to the primary.

Key to SDLC communication is the control characters it uses to maintain data integrity. The figure below shows the six fields that comprise a single SDLC data frame.

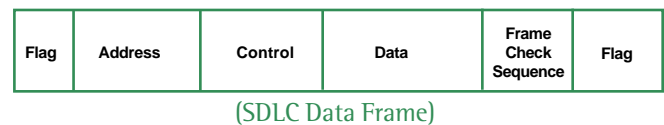

The **Flag** field starts and ends error checking. The **Address** field is used to indicate the intended data destination, and can be a single address, a group of addresses, or a broadcast to the entire network. The **Data** field is the information being transmitted, and the **Frame Check Sequence (FCS)** is generally a Cyclic Redundancy Check (CRC) calculation. A calculation on the transmitted data is done by the transmitter and the result is sent in the FCS. This calculation is then performed by the receiver after data transmission is complete. If the results don't match, an error is assumed.

The **Control** field uses three different formats depending on the type of SDLC frame. The diagram below breaks out the different data bits in the control field. Explanations for the three control formats follow on the next page.

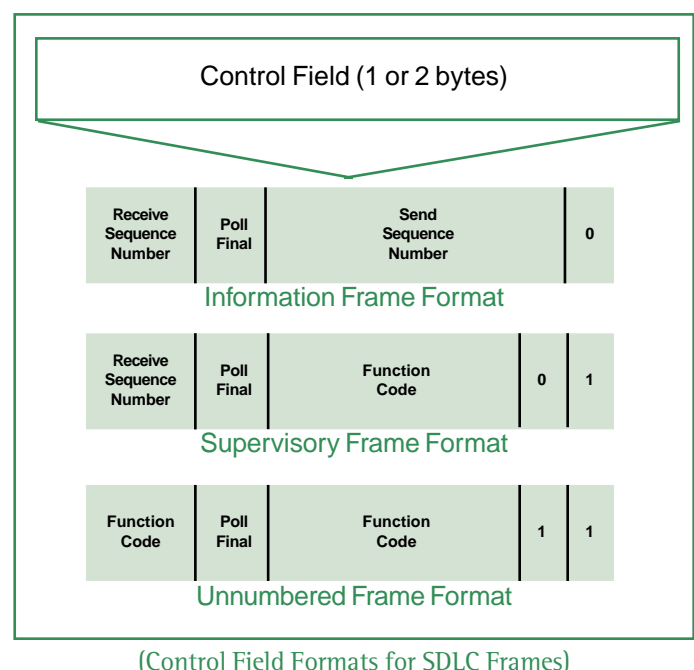

COM

Synchronous and Isochronous Communication

The **Information Frame** is used when actual data is being transmitted. It is also used to provide sequencing, flow and error control functions. The sequence number bits are used to indicate the number of the frame that will be sent/received next, and are used by both the primary and secondary nodes. The **Poll Final** bit is used by the primary to tell the secondary whether or not an immediate response is required. The secondary uses the **Poll Final** bit to indicate whether the current frame is the last in its response, or whether more frames are coming.

The **Supervisory** frame is used to control the communication network. It can request or suspend data transfer, report status, and acknowledge receipt of data. Note that since **Supervisory** frames are used exclusively for control, they do not have data fields.

The **Unnumbered** frame is unsequenced, can contain one or two bytes, and is used to provide miscellaneous control commands. For instance, it might be used by a primary node to activate the secondary nodes in the network.

Another bit-oriented synchronous communication protocol, High Level Data Link Control (HDLC) which is based on SDLC, also uses the frame format described above. However HDLC, which was approved by the International Standards Organization (ISO) in 1979, differs from SDLC in several ways. With HDLC, 32-bit checksums can be used, thereby providing an advantage over SDLC in the sophistication and accuracy of error checking, and thus data integrity. Unlike SDLC, HDLC protocols cannot operate using loop or hub go-ahead configurations (see page 27).

The largest difference between the two, is that SDLC uses only a single transfer mode, while HDLC provides three choices. Both use Normal Response Mode (NRM) in which a secondary node is precluded from communicating with a primary node until the primary gives permission. The two additional HDLC modes are Asynchronous Response Mode (ARM) and Asynchronous Balanced Mode (ABM). In ARM mode, any secondary can initiate communication without receiving permission from the primary. ABM mode requires that all devices be configured as combination nodes that, depending on the situation, can assume the role of primary or secondary in the network. In such a system, any device can initiate communication at any time without permission.

Data Buffers

Though synchronous communication enables transmission of large amounts of data at high speed, it puts in place extensive control and error-checking mechanisms to prevent data

corruption. However, in full-duplex networks using bit-oriented protocols, the transmitter is most likely sending frame B before it knows if frame A was received successfully. (This is not as much of a problem in slower byte-oriented protocols where data flows in only one direction at a time.) To maintain the highest possible data rates, synchronous hardware must contain sufficient data buffers to store transmitted data (for resending if necessary) until a successful transfer is confirmed.

Quatech synchronous serial PCMCIA (see page 54-55) and PCI (see page 68) cards use a 1024-byte FIFO for data buffering. Our ISA synchronous cards (see page 81-83) use DMA. All support both bit and byte protocols, and point-to-point and multipoint full- and half-duplex networks. We also supply SYNCDRIVE software (see page 56) with all synchronous cards. SYNCDRIVE provides hardware specific device drivers, DLLs and APIs to simplify incorporating Quatech boards into your BiSync, SDLC and HDLC applications.

Isochronous

A steady data stream

Unlike asynchronous and synchronous communication, which both involve elaborate error checking mechanisms, the driving force behind isochronous communication is a fast, steady, uninterrupted data stream. Isochronous clocking information is derived from or included in the data stream, and the delay factor is dependent on a channel's characteristics and can be logically determined. Communication can be disrupted if the transmitter does not maintain a constant transfer rate, or if the receiver has an insufficient buffer to store data at the rate it is arriving and then hold it until it can be processed by software. To maintain data transfer speed, error checking is often omitted. Though software can be written to track errors, there is no hardware mechanism by which to request retransmission of corrupted data.

Isochronous communication is best suited for applications where a steady data stream is more important than accuracy. A good example is video conferencing where infrequent small "blips" in the data stream are tolerable, however, long pauses between a transmission and a response are not.

To ensure that isochronous transfers are not bogged down by other devices, the USB specification sets aside bandwidth for them. IEEE 1394 also uses isochronous communication, as it is ideal for the high-speed video and audio applications for which the bus was designed.

Communication Overview

The previous sections have discussed ways in which data is transmitted and received. However, we have yet to discuss what happens to the data between Point A and Point B. This in-between area is a cable made up of wires through which data travels. Specifications for this cable were developed to maximize signal integrity (to limit the possible degradation that could be caused by external noise or ground shifts). There are three main methods for asynchronous and synchronous communication: RS-232, RS-422 and RS-485. Differences between the three are highlighted in the chart below and in the descriptions which follow. The other option is parallel communication, which is described on page 32. As noted earlier, when using USB, IEEE 1394, or any of the wireless interfaces, cabling is part of the bus specification.

SERIAL COMMUNICATION

RS-232

The First Standard

RS-232 was introduced in 1960, and is currently the most widely used communication protocol. It is simple, inexpensive to implement, and though relatively slow, it is more than adequate for most simple serial communication devices such as keyboards and mice. RS-232 is a single-ended data transmission system, which means that it uses a single wire for data transmission. (Since useful communication is generally two way, a two-wire system is employed, one to transmit and one to receive.) Signals are processed by determining whether they are positive or negative

when compared with a ground. Because signals traveling this single wire are vulnerable to degradation, RS-232 systems are recommended for communication over short distances (up to 50 feet) and at relatively slow data rates (up to 20 kbps). However, in practice, these limits can be exceeded.

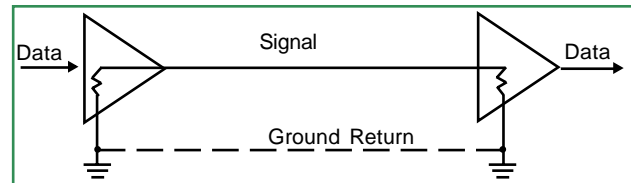

(Unbalanced, Single-wire Transmission)

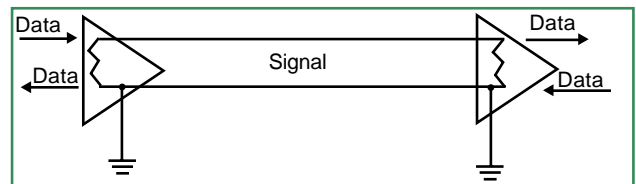

(Unbalanced, Two-wire Transmission)

COM

DTE and DCE: Serial Communication Partners

A typical system is made up of two types of device, data communication equipment (DCE) and data terminal equipment (DTE). Typically DTE is defined as the communication source, and DCE is defined as the device that provides a communication channel between two DTE-type devices. For example, the diagram on page 25 shows two modems (DCE) providing the communication channel between a PC and a mainframe, two DTE devices.

	Single-ended	Differential	Differential
Mode of Operation	Single-ended	Differential	Differential
Drivers per Line	1	1	32
Receivers per Line	1	10	32
Maximum Cable Length	50 feet	4000 feet	4000 feet
Maximum Data Rate	20 kbps	10 Mbps	10 Mbps
Driver Output Maximum Voltage	±25V	-0.25V to +6V	-7V to +12V
Driver Output Signal Level (loaded)	±5V	±2V	±1.5V
Driver Output Signal Level (unloaded)	±15V	±5V	±5V
Driver Load Impedance	3k to 7k	100k	54k
Maximum Driver Output Current (Power On)	n/a	n/a	±100µA
Maximum Driver Output Current (Power Off)	$V_{MAX}/300$	±100µA	±100µA
Slew Rate	30Vµs max.	n/a	n/a
Receiver Input Voltage Range	±15V	-7V to +7V	-7V to +12V
Receiver Input Sensitivity	±3V	±200mV	±200mV
Receiver Input Resistance	3k to 7k	4k min.	12k min.

RS-232 and RS-422/485

In order for DCE and DTE devices to communicate with each other, two wires must be used--one for transmission and the other for reception--and both devices must not use the same wire for the same purpose. Should this happen, nothing would get communicated because both devices would be talking on the same line and listening to a line on which nothing is transmitted.

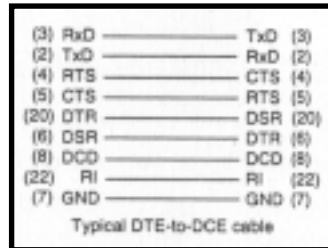

To solve this problem, DTE and DCE devices have complementary pinouts to allow terminals and modems to be connected directly using a one-to-one cable (see above-right).

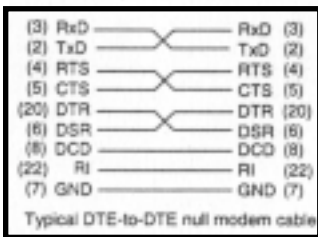

Situations arise in which no DCE device is needed, such as a desktop computer communicating with a laptop. In this case, a null modem cable or **modem eliminator cable** is used to connect the two DTE devices. This cable effectively changes the wires the second device uses for transmission and reception (see above-left) to assure that both sides can communicate.

Connectors: The Communication Conduit

As discussed in the asynchronous and synchronous communication sections, there is more to a serial transmission than simply data. Additional information must be transmitted between both ends of a conversation to make sure that when Point A sends, Point B is listening, and vice versa. This is called **handshaking**. These handshaking lines take-up considerable space on a serial connector.

Connectors for RS-232 devices are always constructed using standard assignments for the wires in a RS-232 cable in order to maintain the DTE-DCE relationship described above. These connectors can be modular (phone jack) or male D-shell (pins configured in a rough "D" shape which fit into sockets on the device). The signal assignments for the RS-232 wires follow. The descriptions reference the standard D-9 and D-25 connectors used by most serial devices, however the definitions are applicable to modular connectors as well (though in modular connections not all of the handshaking signals are implemented). Pages 62, 70-73 and 78 detail Quatech modular adapters for PCI, CompactPCI, and ISA, and include modular connector pinout information.

RS-232 Signal Descriptions

Abbreviations used in the following definitions of RS-232 wire functions will be used throughout the catalog.

DTR: Data Terminal Ready--Used by a DTE to signal that it is plugged in and available to begin communication.

DSR: Data Set Ready--Sister signal to DTR, it is used by the DCE to indicate it is ready to begin communication.

CTS: Clear to Send--Used by DCE to signal it is available to send data, and also used in response to an RTS request for data.

RTS: Request to Send--Used by a DTE to indicate that it wants to send data. Also, in a multi-drop network, used to turn carrier on the modem on and off.

DCD: Data Carrier Detect--Used by a DCE to indicate to the DTE that it has received a carrier signal from the modem and that real data is being transmitted.

RI: Ring Indicator--Used by a DCE modem to tell the DTE that the phone is ringing and that data will be forthcoming.

TxD: Transmit Data--This wire is used for sending data.

RxD: Receive Data--This line is used for receiving data.

GND: Signal Ground--This pin is the same for DTE and DCE devices, and it provides the return path for both data and handshake signals.

Synchronous Communication Only

TxCLK: Transmit Signal Element Timing--Used by DTE to provide DCE with timing information for data transfer.

RxCLK: Receiver Signal Element Timing--Used by DCE to provide DTE with timing information for data transfer.

LLBK: Local Loopback--Used by DTE to make sure the local transmit and receive interface is functioning properly.

RLBK: Remote Loopback--Used by DTE to make sure a remote transmit/receive interface is functioning properly.

TEST MODE: Test Mode--Used by DCE to indicate that it is testing itself in response to a local or remote loopback signal from a DTE.

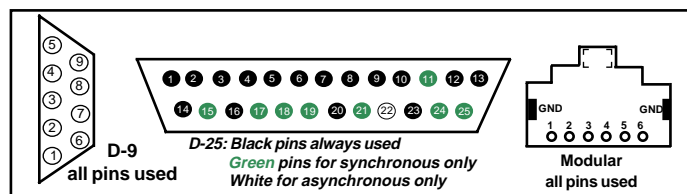

(RS-232 Serial Connectors)

RS-422

Balanced Transmission

The RS-422 protocol greatly expands the practical possibilities of the serial bus. It provides a mechanism by which serial data can be transmitted over great distances (to 4,000 feet) and at very high speeds (to 10 Mbps). This is accomplished by splitting each signal across two separate wires in opposite states, one inverted and one not inverted. The difference in voltage between the two lines is compared by the receiver to determine the logical state of the signal. This wire configuration, called differential data transmission or balanced transmission, is well suited to noisy environments. With RS-232 communication, which is unbalanced transmission and uses only one wire, signal degradation can take place if there is a difference in ground potential between the transmitting and receiving ends of the cable. With balanced transmission, this potential difference will affect both wires equally, and thus not effect their inverse relationship. Twisted pairs of wire, which ensure that neither line is permanently closer to a noise source than the other, are often used to best equalize influences on the two lines. Errors can be caused by high noise levels affecting one side of the receiver to a different extent than the other. To combat this, each receiver is generally grounded.

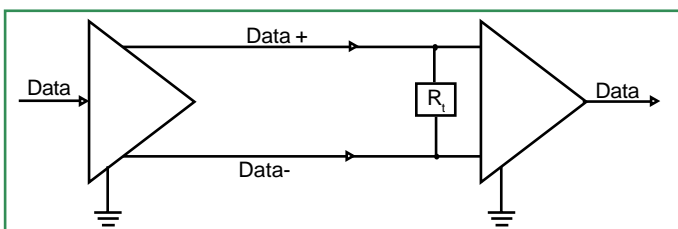

(Balanced Transmission)

Errors in *balanced transmission* systems such as RS-422 can also be caused by signal reflections. As data transfer speeds increase and travel over longer distances, the signal can be reflected back from the far end of the wire. To combat this, termination resistors are placed at the far end of the cable which make the cable appear electrically as if it is infinitely long--infinitely long lines don't have ends, and thus can't reflect from one end to the other. These termination resistors will differ depending on the protocol used. For RS-422 a 100 ohm resistor is placed at the receiving device.

Full-Duplex, Half-Duplex, and Multipoint Systems

An RS-232 based system allows only two devices to communicate. With RS-422 a master can use one communication line to converse with up to 10 slaves. With that many parties wanting to talk, a mechanism for controlling the conversation must be implemented.

Two such mechanisms exist: Full-Duplex and Half-Duplex. In Half-Duplex operation communication can take place in only one direction at a time. This is an obvious solution to a balanced system employing only one set of wires--if signals were coming in both directions at once, they would conflict with each other. However, even systems in which different pairs of wire are used for transmission and reception can still operate in Half-Duplex mode. In such a case, each data exchange is predicated upon the previous one, and will not take place without proper handshaking.

In Full-Duplex systems, transmission and reception can occur at the same time. Thus Point A can send information to Point B while at the same time receiving data from Point B. Full-Duplex operation becomes especially important in systems where a single master is communicating with multiple receivers. With a Full-Duplex configuration, Point A can send data to Point B while receiving data from Point C.

The nature of a Full-Duplex system lends this configuration to a network of multiple devices communicating with each other using a single data line. However, the RS-422 protocol does not permit this type of communication. With RS-422 there can be only one driver, though there can be up to 10 receivers. Thus, only the master Point A can communicate directly with points B through K. If Point C wants to transmit data to Point H, it must go through Point A to do it.

RS-485

The True Multidrop Network

RS-485 is an upgraded version of the RS-422 protocol that was specifically designed to address the problem of communication between multiple devices on a single data line. It is a **balanced transmission** system that is virtually identical to RS-422 with the important addition of the ability to allow up to 32 devices to communicate using the same data line. Thus any Point A through Point FF can directly communicate with each other, taking on the role of master and slave as needed. This is achieved with tristatable drivers which are usually controlled by a programmable handshake line to ensure that only one device acts as a driver at any one time.

In such a system, the RS-485 line cannot be thought to have a beginning and an end, because communication can be initiated from any point on the line. Thus, terminating resistors must be placed at both ends of the RS-485 wire to achieve the infinite line illusion. For RS-485, 120 ohm resistors are placed at the two furthest points of the communication link.

Parallel Communication

PARALLEL COMMUNICATION

In the Beginning

The original 8-bit parallel port was developed by IBM in 1981 as a faster interface to dot matrix printers than the then standard one-bit serial port. The parallel port greatly increases transfer speeds by using an 8-wire connector that transmits the eight bits in a byte of data simultaneously, thus sending an entire byte of data in the time it takes to send a single bit in a serial system. This byte of data is supplemented by several other handshaking signals, each sent on its own wire, which ensure that data transfer takes place smoothly.

The major drawback to the original parallel port or *Standard Parallel Port* (SPP) was that it allowed for communication in only one direction--computer to printer. While there were wires which the printer could use to indicate its status to the computer, it could do no more than put a positive or negative charge on these wires. (See chart below for a comparison of parallel protocols.) This arrangement effectively limited the parallel port's potential and precluded it from being used in bidirectional communication such as is required for external storage devices.

The EPP Advantage

IBM soon realized the advantages to be gained from enabling the parallel port for bidirectional communication. While early bidirectional efforts did indeed provide for two way transfer, they did little to make the parallel port a viable alternative for high speed data transfer.

To address this problem, a new standard for parallel communications, known as IEEE 1284 (for the committee which established it), was approved in 1994. This new standard sought to correct the major drawbacks to the original parallel port structure. The first major drawback was that not all parallel peripherals used the same mechanical interface, and thus the maximum cable distance between computer and peripheral could

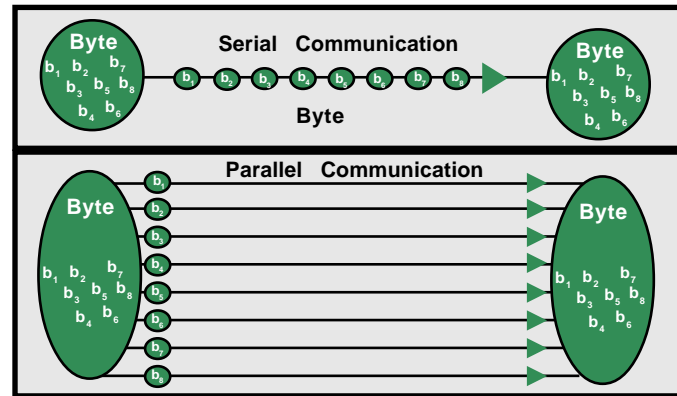

(Serial vs. Parallel Communication)

only extend 6 feet. IEEE 1284 sets standards for the cable, connector and electrical interface that guarantees interoperability between all parallel peripherals. The specified configuration ensures that data integrity is maintained, even at the highest data rates, and at a distance of up to 30 feet.

IEEE 1284 also set design standards for true bidirectional communication between devices. However, the real advance came with the *Enhanced Parallel Port* (EPP). EPP utilizes data cycles that not only enable bidirectional communication, but also provide for real-time data transfers by permitting intermixing of block transfers, read operations and write operations.

The EPP specification also solves the speed problem. Parallel data transfer was largely performed by software in SPP systems, and thus data transfer rates were limited to 150 kbps. The new EPP standard specifies a hardware driven handshake system of data transfer that allows significantly higher transfer speeds--up to 2 Mbps. In EPP mode, data transfer takes place as a single software instruction, and the rest of the transfer is handled by hardware. This allows an EPP port to function as a 16- or 32-bit data transfer interface using 8-bit I/O hardware, in effect enabling EPP peripherals to achieve the same speed and efficiency as many of their board-level counterparts.

Pin	SPP Func
1	STROBE: Used by computer to tell pr character has been transmitted and is
2-9	Data transmission from computer to pi
10	ACK: Used by printer to tell computer the transmitted data and is ready for n
11	BUSY: Used by printeer to regulate de
12	PE: Used by printer to tell computer it
13	SELECT: Used to indicate to the comj
14	AUTOFEED: Printer carriage return
15	ERROR: Printer indicates an unspecifi
16	INIT: Computer initializes printer
17	SELECTIN: Allows a printer to be bro
18-25	Ground

Wireless Communication

The bus interfaces discussed in the previous sections all require a wired connection between PCs and peripheral devices. While practical for many applications, they cannot provide the flexibility of wireless systems. Advances in wireless technology have been occurring at a remarkable pace. The following sections cover the technologies around which Quatech is currently developing products. The table to the right provides a comparison of the features available for each choice.

Interface	Speed	Range	OS Support	Protocol	Antenna
RF Modem	57.6 kbps	500 meters line-of-sight	Windows 3.1/95/98/Me/2000 and DOS	DSSS with GMSK modulation	external
802.11b	up to 1Mbps	100 meters line-of-sight	Windows 98SE/Me/2000/CE	DSSS (QPSK and BPSK with CCK modulation)	embedded
Bluetooth™	723 kbps	10 meters (with obstacles)	Windows 98SE/Me/2000/CE	Bluetooth (FHSS)	embedded

DSSS

Introduction to Spread Spectrum Technology

Spread Spectrum (SS) technology is not very new (relatively speaking). An actress, Hedy Lamarr, invented SS in WWII with the aid of an avant-garde composer named George Antheil. Spread Spectrum was originally designed to hide the signals that controlled torpedoes. The topic was classified by the U.S. military, and only recently were the patents made public. Although the Navy decided not to use the invention in WWII, the U.S. government began using the technology in the '50s and '60s to keep communications secret.

Today, there are basically two types of SS: Frequency Hopping (FH) and Direct Sequence (DS). There is also a third classification called Hybrid, which is a combination of DS and FH. As processor speeds have increased, these technologies have found greater use in commercial products. Notice that FH and DS are not modulation techniques, but are coding techniques to disperse the signal in the frequency domain.

Frequency Hopping

Frequency Hopping radios most closely utilize the methodology of Lamarr and Antheil. They implemented the design with a player piano roll with 88 "pseudo-random" (PN) notes. Current systems use synthesized Voltage Controlled Oscillators (VCO) to rapidly change transmit frequencies.

Bluetooth uses 79 pseudo-random hopping frequencies set 1MHz apart, and uses Frequency Shift Keying (FSK) modulation to send ones and zeros. (See page 34 for more on **Bluetooth**.) If the transmit frequency moves up at least 115kHz, then it is a one. If it moves down at least 115kHz then it is a zero. The biggest hurdle is synchronizing the receiver and the transmitter to the same hopping sequence. **Bluetooth** can theoretically provide about 723kbps net throughput.

COM



(FHSS (Frequency Hopping) Spectrum)

DSSS and Bluetooth

Direct Sequence Spread Spectrum

Direct Sequence radios use the PN code to divide or slice up the data to be transmitted from “bits” into “chips.” The chipping rate is generally an order of magnitude faster than the data signal. These chips are then modulated and transmitted. It is the job of the PN-code to make the transmitted signal wide. Properly spread signals have a sinc^2x type PSD.

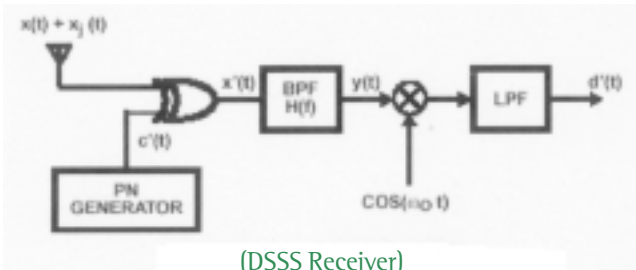
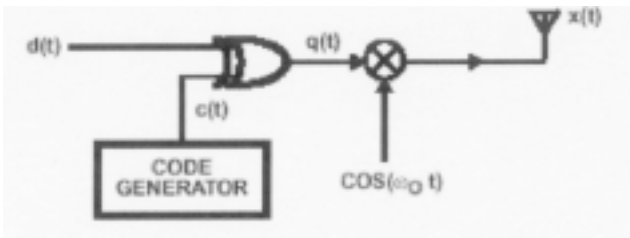

The IEEE 802.11b specification uses Binary Phase Shift Keying (BPSK) and Quadrature Phase Shift Keying (QPSK) modulation. PSK works by detecting the phase of the incoming signal and determining its value. The phase relationships are 180° out of phase in the BPSK scheme. This means that the bit was either a one or a zero, and the receiver simply looks for phase inversions. In QPSK, signals are 90° out of phase, and provide twice the throughput of the BPSK system.

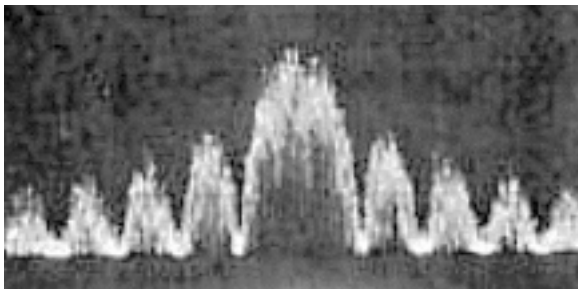

(DSSS Spectrum (BPSK modulation))

	0°	90°
BPSK	0	n/a
QPSK	00	01

MSK and GMSK

Minimum Shift Keying (MSK) is a special form of FSK that uses minimum spacing and no phase inversions. It uses a continuous phase modulation scheme where frequency changes occur at the carrier zero crossings. With MSK the difference between the frequency of a logical zero and a logical one is always equal to half the data rate. Thus, the modulation index is 0.5 for MSK, as shown in the diagram below:

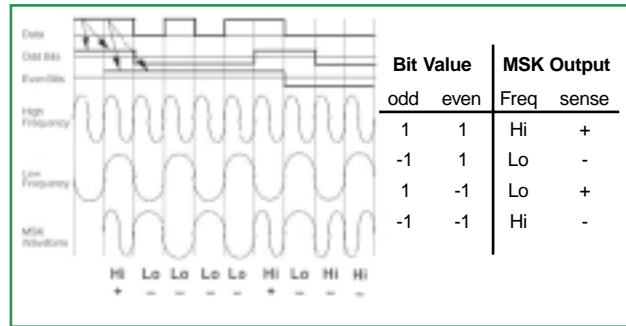

(Minimum Shift Keying (MSK))

A large problem with using MSK for high speed applications is that the MSK is not compact enough to fully utilize the available RF bandwidth. To more efficiently use available bandwidth, it is necessary to reduce the energy of the MSK upper sidelobes via lowpass filtering. To do this, a Gaussian filter, characterized by a Gaussian distribution (bell shaped curve), is used to provide a cutoff frequency with very little overshoot in its impulse response. Gaussian Minimum Shift Keying (GMSK) is used by Quatech’s QTM-8424 DSSS modem modules. GMSK makes much more efficient use of bandwidth and power than does MSK due to its low base-band and harmonic content. The diagram below provides a comparison of the two waveforms.

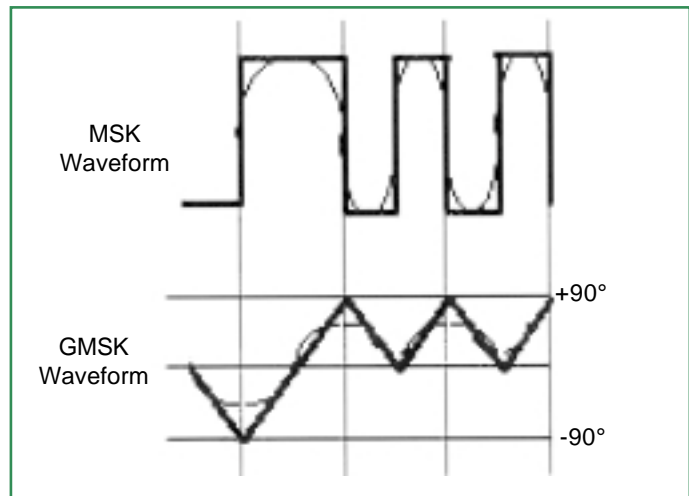

(MSK vs. GMSK modulation)

BLUETOOTH™

A Short-Range Mobile Solution



Bluetooth is a specification for a small form-factor, low-cost, short-range radio solution for providing links between mobile computers, mobile phones, and other portable and hand-held devices, and for providing connectivity to the internet. It is based on a radio link that provides fast and reliable transmission of both voice and data. It can carry up to three high-

quality voice channels simultaneously at speeds to 721 kbps, even in noisy environments. Like USB (see page 22) and IEEE 1394 (see page 24), the specification incorporates both rules for implementing the interface and rules for designing compatible peripherals for the network.

The **Bluetooth Special Interest Group (SIG)**, comprised of leaders in the telecommunications, computing, and network industries, is driving development of the technology and bringing it to market. As an Associate Member of the SIG, Quatech is kept up to date on all the latest specifications, so you can be sure that all **Bluetooth** products from Quatech will be compatible with other **Bluetooth** devices on the market.

Connectivity

Bluetooth allows users to connect to a wide range of devices at one time without cables, and potentially without actively initiating the connection. For example, your PDA could automatically update a copy of your schedule stored on a desktop PC the minute you walked into your office. This connectivity is enabled by a tiny microchip incorporating a radio transceiver that is built into **Bluetooth** devices. This radio transceiver provides the advantage of being effective through obstacles. Thus, you could ostensibly use a **Bluetooth** connection to send data from a computer in one room to a printer in the next--right through the wall.

One concern when using such a system is privacy. As **Bluetooth** operates in the globally available 2.4 GHz frequency, it is conceivable that an unintended recipient could intercept a signal. To combat this, all **Bluetooth** devices are keyed for their own networks. The transmissions use a sophisticated encoding specification that not only guards against interference, it also ensures that only devices specifically programmed to receive a broadcast will be able to decode it.

Bluetooth uses a flexible, multiple piconet structure for communication. It supports both point-to-point and multipoint connections for full-duplex networks. Currently up to seven slave

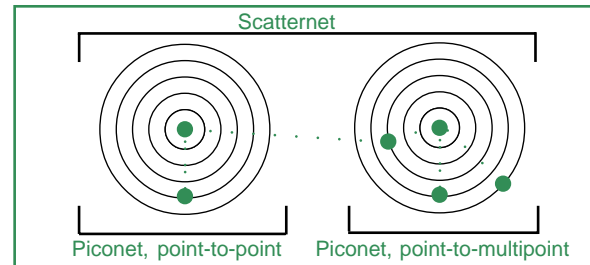

(Bluetooth multiple piconet communication structure)

devices can be configured to use a master radio in one device. Several of the piconets can be established and linked in scatternets to allow flexibility among configurations. Devices in the same piconet have priority synchronizations, but other devices can enter the network at any time. In a full-duplex network, a multiple piconet structure with 10 fully loaded, independent piconets, can maintain aggregate data transfer speeds of up to 6 Mbps.

High and Low Power

The **Bluetooth** specification implements two power levels: a low power level designed for short distance communication such as within an office, and a high power level that can accommodate a medium range, such as an entire building. Additionally, **Bluetooth** limits power output to exactly what the device requires at any given time. For instance, when two devices connect and determine that they are close together, the transmitter immediately modifies its signal to the strength needed to accommodate that range. When traffic volume across a connection slows down, or stops completely, a receiving device will shift to a low power sleep mode that is intermittently interrupted for very short periods in order to maintain the network connection. With these power saving features, **Bluetooth** devices consume very small amounts of power, making them ideal for portable applications.

Bluetooth for Data Communication

Bluetooth technology makes data communication fast, easy, and convenient. As speeds and distances are currently limited, it should be viewed as a short-range solution for low to medium speed applications. It does provide remarkable flexibility, by communicating through walls and other obstacles, that makes it an ideal choice for home or office networks--for example sharing a printer among multiple PCs located in different rooms on the same floor. It also expands the functionality of a mobile phone, allowing it to serve as a modem for internet connections, or allowing it to communicate with other devices--such as the prospect of using mobile phones to purchase drinks from vending machines.

*Bluetooth is a trademark owned by the Bluetooth SIG, Inc. and used by Quatech, Inc. under license.

COM

Application Examples

Application Examples

Quatech's extensive data communication line is designed to provide solutions for a wide range of serial and parallel applications. The examples which follow are drawn from real-life systems implemented with Quatech products. These examples are by no means exhaustive, but are merely meant to illustrate how our cards fit into different categories of data communication applications.

If after reading this introduction and perusing product specifications you are still not sure of an appropriate choice, feel free to call one of Quatech's expert sales engineers to discuss your application. We are always available to help you, and if necessary, to suggest custom card configurations which may meet your needs better than our standard product line.

ASYNCHRONOUS SERIAL

Serial data transfer is the communication backbone for the majority of today's applications. Quatech asynchronous serial products are available with up to eight ports on a single card, and are an ideal solution for multi-port systems in numerous applications including:

- Office Automation
- Banking Teller Networks
- POS Systems
- Navigation Systems
- RS-232 Networks (LAN Link, Easy Link)
- Low Cost Multi-Drop Networks
- Multiuser Systems
- Bulletin Board Systems
- Factory Automation
- Process Control
- Testing Systems
- Security Systems
- PBX Systems

Desktop Applications

Adding Serial Peripherals

While it may seem obvious, Quatech serial communication boards can be used for adding additional serial ports to a desktop computer. Our multi-port serial boards can be used to connect digital cameras, serial modems, mice, plotters, serial printers, or a wide variety of data acquisition and signal conditioning equipment designed to run on a serial interface.

Point of Sale Systems

Quatech RS-422 serial boards are currently being used to implement Point-of-Sale (POS) systems in retail outlets throughout the world. The Quatech board is used as the communication link between a host computer and a network of cash registers and coupon printers. RS-422 boards were chosen for this application because of the long-distance serial link needed (signals in an RS-422 network can be transmitted over 4,000 feet). In addition, the multi-point communication capabilities of RS-422 were desirable because a single COM line could be used to control 10 separate devices. Using one of Quatech's four-port serial boards permits a single card to control up to 40 devices (20 coupon printers and 20 registers)--more than enough for the average store. For simplicity, RS-422 was employed because the individual peripherals needed only to communicate with the master, not with each other. (Had all points in the system needed to talk to each other, then RS-485 would have been the better choice, even though implementing the system would have cost more.)

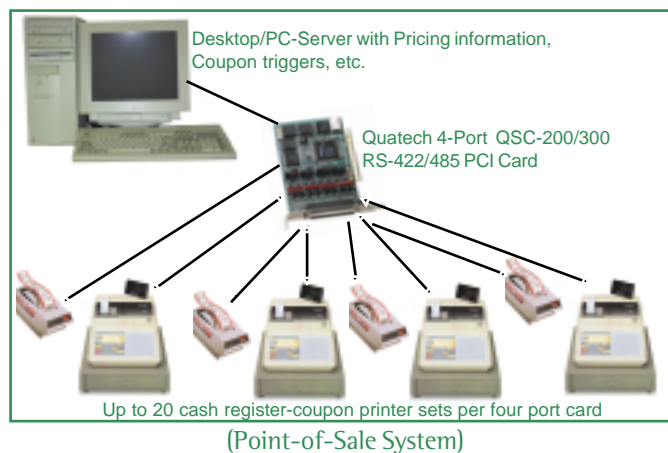

A typical point-of-sale system is pictured above. The PC contains all the data needed by individual registers and coupon printers throughout a retail location. Quatech PCI or ISA asynchronous RS-422 serial boards are installed in PC expansion slots. The number of expansion slots available in a system will vary with each PC. RS-422 cables are run between the adapter and the individual serial printers and serial registers. The cashier presses buttons on the register which transmit the item purchased to the host computer through one serial line, the host then returns the appropriate price to the register so it can be displayed for the customer. The host also checks the purchase against a file of potential coupons, and if the purchase qualifies for a special offer, the host sends the printer instructions to print a particular coupon. (A similar system could also be implemented using a serial bar code reader instead of or in conjunction with a register.)

Communication Overview

Banking Teller Networks

Quatech RS-232 serial boards are currently being used in international banking applications to construct teller networks. Clearly, it would not be economical for each branch of a multinational bank to keep data for the entire organization on their own PC. At the same time, they need instantaneous access to that central data, so that customers can be serviced at any of the branches. Further, not only must each branch have access to the data, but each teller station as well. The teller also needs to be able to print checks for customers, get account information from a customer's bank card, and of course check balances and credit or debit accounts.

A simple, inexpensive RS-232 serial network is ideal for connecting multiple devices over short distances that are in turn linked with a database which may be located on the other side of town, or on the other side of the world.

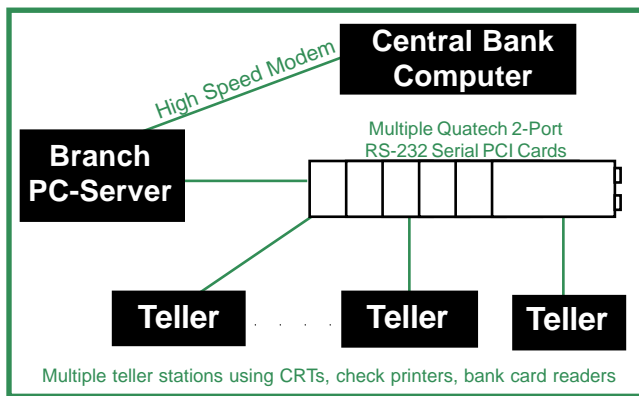

(Banking Teller Network)

As shown in the above diagram, the heart of the teller network is the central computer which contains account information for all the bank's customers. The branch computer links to the central computer via a high-speed modem. Each individual teller has multiple serial links to the branch computer which connect CRTs, check printers, and bank card readers. This connection is made through a series of RS-232 serial ports. Many of these networks are used in OS/2 environments, because of the high stability and reliability of that operating system. Our customers are currently using Quatech DS-100 and DSC-100 two-port ISA and PCI cards for this purpose. However, Quatech RS-232 cards also come in four- and eight-port versions, all of which are supported under OS/2, allowing more devices to be connected using a single card.

Virtual Gaming

Quatech's DSC-200/300 serial PCI board is currently being used to implement the MultiSport Stadium interactive sports simulator. In this virtual dream machine, players use real balls to compete against life-size video athletes. These on-screen athletes react in real time to the live player's throw, pass or pitch.



(MultiSport Stadium interactive sports simulator)

The system utilizes infrared sensors to detect the trajectory of the real ball after it has been launched by the player. This real-time communication process is made possible by Quatech's two port RS-422 serial I/O board, the DSC-200/300, which allows the PC to communicate with both pairs of Newton Lab sensors. One of the serial ports communicates with the down-range array and the other with the up-range array.

The computer then analyzes this information and projects a virtual ball to continue the flight into 3-D space on-screen. At the same time, the computer selects and runs an appropriate video script from a library of pre-captured footage. The result is a seamless interactive sports experience, in which the player enjoys the thrill of playing in a pro stadium against top athletes.



(Interactive sports simulator in action)

COM

Application Examples

Portable Applications

Adding Serial Peripherals

As with desktop systems, Quatech serial PCMCIA communication cards and serial USB adapters can be used for adding additional serial ports to a laptop computer. Most laptop computers come with only one serial port, and this port is often used for an external mouse (usually because of the inconvenient nature of built-in trackballs). The need for adding portable peripherals to laptops is even greater than it is for desktops. Quatech multi-port serial cards can be used to connect digital cameras, serial modems, mice, plotters, serial printers, GPS receivers, or a wide variety of data acquisition and signal conditioning equipment designed to run on a serial interface.

Data Collection and Control in the Field

Quatech multi-port serial PCMCIA cards are ideal for a wide range of field testing applications. Our customers currently use our cards for programming PBX systems. During Supertanker speed trials and maneuvers, Quatech cards are used to interface with ship bridge equipment for navigational purposes. They can also be used with RS-232 or RS-485 data acquisition equipment for a wide variety of process and monitoring applications.

Real-Time Court Reporting Systems



(Portable Court Reporting System)

The diagram above depicts a typical court reporting system that will permit real-time display of testimony on multiple remote monitors located throughout a courtroom. The system depends on a dual RS-232 serial connection, one port for the shorthand machine and the other to connect to the monitoring network. As most laptops have only one serial port (which may be occupied by a mouse), Quatech's DSP-100 two-port RS-232 serial card is an ideal choice for implementing this system.

Animal Management Systems

One Quatech customer has created an animal management system that enables ranchers and feedlot operators to better manage their operations by providing an electronic system to track beef from ranch to refrigerator case. Using technologies such as computerized ear tags, DNA tracking, bar codes, and computer networks, data is collected and stored in an animal data and tracking information system. This information is shared by everyone along the supply chain--ranchers, feedlot operators, packing plants, processors, distributors, supermarkets, and restaurants--to better manage product quality, profitability and especially food safety.



Scanning a calf's ear-tag

With so many different inputs, a standard laptop has insufficient ports to handle the job. To solve the problem, Quatech DSP-100 and QSP-100 (two and four port RS-232 serial PCMCIA cards) are used to increase serial capability in laptops that are used for data collection. For instance, as a head of cattle is weighed, the DSP-100 collects the serial string output from the RS-232 weigh scale. Once the initial weight is stored, it can be used to calculate

parameters such as Average Daily Gain, which in turn is used to forecast weeks to slaughter.

Quatech multi-port RS-232 PCMCIA devices are also used to collect data from other serial devices such as thermometers, ultrasound scanners, and bar code scanners. For example, an electronic bar code identification tag is attached to a calf's ear before it comes to the sale barn. Each tag has the calf's identity bar coded on it. That code is scanned by a bar-code reader attached to a laptop with a DSP-100, and the tracking software then creates a database entry for that calf. Whatever is done to the calf over its life is recorded in the database along with the pasture and feedlot performance records. When the animal is slaughtered, carcass data can also be entered. This streamlined system of data recording, analysis, transfer and reporting on individual calves, provides performance information from conception to consumption to assist in reaching food quality targets. It also provides complete traceback capabilities for food safety guarantees.



Bar-coded ear tag

Radiation Mapping with a PDA

Mapping radiation contamination after accidents or at waste disposal sites demands complete accuracy and the ability to pinpoint contaminated areas. There are commercially available systems with which to do this, however they are typically large costly units. To solve the problems of both cost and portability, one Quatech customer has developed a radiation mapping system around a palmtop computer.

The system is comprised of an HP200LX palmtop (PDA) equipped with both a built-in serial port and a PCMCIA slot. A Global Positioning System (GPS) receiver is connected to the built-in RS-232 port. Quatech's DSP-100 dual serial port card provides two additional RS-232 ports via the PCMCIA slot.



(PDA with DSP-100 installed, connected to a GPS system and a Geiger counter)

Each of those ports is connected to a Geiger counter, which triggers an interrupt on the palmtop every time a radiation event is detected. Gamma radiation dose rate and location are collected for processing with a Geographical Information System (GIS).

The system is presently being used for mapping background terrestrial radiation. It is sufficiently sensitive to accurately measure the environmental levels of radiation. Because of the small size of the PDA itself, and the equipment connected to it, the system can be mounted on a backpack, enabling walking surveys for detailed mapping of possibly contaminated areas. The system can also be mounted on a jeep to survey larger areas.



(Radiation mapping system mounted on a jeep)

Marine Navigation

All boaters, recreational or business, could benefit from a radar system on their vessel. However, many systems are too large or too expensive for typical boaters to use. One Quatech customer has created a radar system that allows even small boats to benefit from radar functions found on large ships.

The system begins with a radar transceiver mounted high-up and outside of a boat. The transceiver sends the information it has collected to a PC-based navigation station via a RS-422 port added to the system via a Quatech RS-422/485 USB adapter. (Quatech RS-422/485 USB adapters are available with 2, 4, 8, or 16 ports. See page 88 for product specifications.) The RS-422 protocol was chosen because it is capable of passing high speed data over long cable runs and is not susceptible to shipboard noise. After the information is sent to the PC via the serial interface, a radar image is displayed on the monitor. Specialized software turns an "off-the-shelf PC" into a radar control center with many of the functions found on big-ship radar systems. Boaters can track their own vessels, find fishing "hotspots," be warned of incoming targets and their positions, as well as overlay radar images on raster and vector charts—a feature unique to this system. All of this is accomplished through a typical PC.

COM



(Radar transceiver with monitor displaying GPS data)

Quatech's Application Services team (see page 212) is currently working with this customer to provide a custom USB solution, offering one RS-232 port and one RS-422 port. The RS-422 port will continue to transmit the information from the radar transceiver to the PC, while the RS-232 port will allow serial position information from a Global Positioning Satellite (GPS) receiver to be fed into the PC at the same time.

Application Examples

SYNCHRONOUS SERIAL

When synchronous systems were first implemented they were able to achieve much higher data transfer speeds than asynchronous systems. However, with the advances in asynchronous communication, most notably clock-multiplying enhanced serial cards, asynchronous cards now approach synchronous speeds. Synchronous transfer is much more software intensive than other methods, however, it is still the ideal choice for applications, including:

- Radar Control
- GPS Systems
- T1 and Fractional T1 Pipelines
- Internet Backbones
- Satellite Monitoring
- Accessing Mainframes and AS400 systems

High Speed Data Retrieval

Quatech's MPAP-200/300 RS-422/485 synchronous serial PCMCIA card is currently being used to interface with the flight recorders found in a wide variety of military and commercial aircraft. The flight recorder, commonly known as the "black box," is responsible for recording what went wrong during a tragic flight, and is also responsible for recording maintenance, structural, and engine data. Maintenance personnel at the aircraft base download this data directly after each flight. Immediate maintenance can then be performed on the aircraft, reducing downtime and saving money for the aircraft fleets.

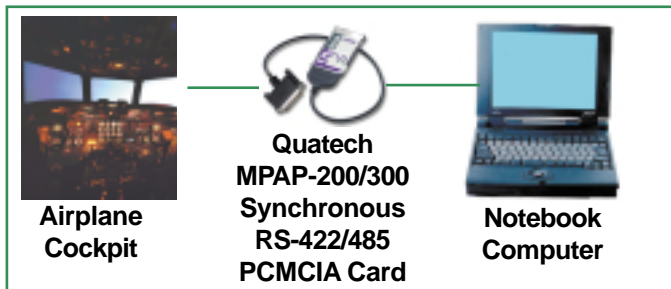

(Flight recorder data retrieval system)

A typical system is pictured above. The recorder stores flight information and voice data in solid state memory. An operator, using a portable PC containing a custom version of Quatech's card, uploads and downloads data to/from the recording system. The high speed synchronous RS-422 interface (up to 4 Mbps!) allows data to be downloaded in minutes. The PCMCIA card is connected to the recorder with a serial interface cable. This portable arrangement is advantageous because the same system can be shared among an entire fleet.

PARALLEL

The parallel port is a fast, simple way to connect a wide variety of peripherals to a PC. The high-speed EPP port makes parallel communication even more attractive by permitting parallel peripherals to transfer data at speeds virtually equivalent to their ISA counterparts. Quatech boards allow adding any parallel peripheral, including:

- Printers
- Zip/Jaz Drives
- CD ROM Drives
- Plotters
- Scanners
- EEG Machines
- Data Acquisition Devices



(Desktop PC with four installed parallel devices)

Expanding a Desktop PC

To show that we actually do use our own products, Quatech's Media Manager's computer system is pictured above. (This is the very system on which this catalog was created.) Our DSDP-100 dual serial, dual parallel interface board is installed in the system's ISA expansion slot. The built-in parallel port is used to connect with the Zip drive, upon which the laser printer is backpacked. One DSDP parallel port is used for the scanner, and the other for the color ink jet printer. The digital camera with which this picture was taken also connects to the system via a parallel port. These peripherals could be added to a laptop computer using Quatech's SPP-100 parallel PCMCIA card.

Medical Applications

Because of the high speed (up to 2 Mbps) EPP port made available by Quatech's SPP-100, it is an ideal choice for a variety of portable medical applications. Several companies have developed proprietary EEG machines which connect with a laptop computer via Quatech's card. The parallel port on many laptop computers will not function in EPP mode under Windows 95/98. Quatech's SPP-100 will. In fact, our card is the only one available that completely adheres to the IEEE 1284 EPP specification.

Data Communication Product Selection Guide

USB Product Features Guide

Model	Protocol	UART	Ports	Cable	Page
SSU-100	RS-232	16550	1	CP-USB included	86
DSU-100	RS-232	16550	2	CP-USB included	86
QSU-100	RS-232	16550	4	CP-USB included	86
ESU-100	RS-232	16550	8	CP-USB included	86
HSU-100	RS-232	16550	16	CP-USB included	86
DSU-200/300	RS-422/485	16550	2	CP-USB included	88
QSU-200/300	RS-422/485	16550	4	CP-USB included	88
ESU-200/300	RS-422/485	16550	8	CP-USB included	88
HSU-200/300	RS-422/485	16550	16	CP-USB included	88

COM

PCMCIA Product Features Guide

Model	Protocol	UART	Ports	Cable	Page
SSP-100	RS-232	16550	1	CP-SSP-100 included	50
DSP-100	RS-232	16550	2	CP-DSP-100 included	50
QSP-100	RS-232	16550	4	CP-QSP-100 included	50
SSP-200/300	RS-422/485	16550	1	CP-SSP-200/300 included	52
DSP-200/300	RS-422/485	16550	2	CP-DSP-200/300 included	52
QSP-200/300	RS-422/485	16550	4	CP-QSP-200/300 included	52
MPAP-100	RS-232 synchronous	Z85230	1	CP-MPAP included	54
MPAP-200/300	RS-422/485 synchronous	Z85230	1	CP-MPAP included	55
SPP-100	Parallel/EPP	n/a	1	CP-SPP included	49
DFP-100	IEEE 1394	n/a	2	included	57

Product Selection Guide

PCI/CompactPCI Product Features Guide

Model	Interface	Protocol	UART	Surge Suppression	Ports	Connector	Cable	Page
DSC-100	PCI	RS-232	16750	no	2	D-shell	none	64
DSC-100IND	PCI	RS-232	16750	yes	2	D-shell	none	64
QSC-100	PCI	RS-232	16750	no	4	D-shell	CP-QS included	64
QSC-100IND	PCI	RS-232	16750	yes	4	D-shell	CP-QS included	64
ESC-100D	PCI	RS-232	16750	no	8	D-shell	CP-ES included	62
ESC-100IND	PCI	RS-232	16750	yes	8	D-shell	CP-ES included	62
ESC-100M	PCI	RS-232	16750	no	8	6-pin modular	CP-RJ8 optional	62
ESC-100MIND	PCI	RS-232	16750	yes	8	6-pin modular	CP-RJ8 optional	62
DSC-200/300	PCI	RS-422/485	16750	no	2	D-shell	none	66
DSC-200/300IND	PCI	RS-422/485	16750	yes	2	D-shell	none	66
QSC-200/300	PCI	RS-422/485	16750	no	4	D-shell	CP-QS optional	66
QSC-200/300IND	PCI	RS-422/485	16750	yes	4	D-shell	CP-QS optional	66
MPAC-100	PCI	RS-232 synchronous	Z85230	n/a	1	D-shell	none	68
TFC-100	PCI	IEEE 1394	n/a	n/a	3	1 6-pin 2 4-pin	included	69
DSCP-100D	CompactPCI	RS-232	16750	n/a	2	D-shell	none	70
DSCP-100M	CompactPCI	RS-232	16750	n/a	2	10-pin modular	none	70
QSCP-100D	CompactPCI	RS-232	16750	n/a	4	D-shell	CP-QS included	70
QSCP-100M	CompactPCI	RS-232	16750	n/a	4	10-pin modular	none	70
DSCP-200/300D	CompactPCI	RS-422/485	16750	n/a	2	D-shell	none	72
DSCP-200/300M	CompactPCI	RS-422/485	16750	n/a	2	10-pin modular	none	72
QSCP-200/300D	CompactPCI	RS-422/485	16750	n/a	4	D-shell	CP-QS optional	72
QSCP-200/300M	CompactPCI	RS-422/485	16750	n/a	4	10-pin modular	none	72

Communication Overview

ISA Product Features Guide

Model	Protocol	UART	Surge Suppression	Ports	Connector	Cable	Page
DS-100S	RS-232	16550	no	2	D-shell	none	74
DS-100IND	RS-232	16550	yes	2	D-shell	none	74
DS-100-750	RS-232	16750	no	2	D-shell	none	74
QS-100DS	RS-232	16550	no	4	D-shell	CP-QS included	74
QS-100IND	RS-232	16550	yes	4	D-shell	CP-QS included	74
QS-100D-750	RS-232	16750	no	4	D-shell	CP-QS included	74
QS-100MS	RS-232	16550	no	4	modular	CP-RJ4 optional	78
ES-100DS	RS-232	16550	no	8	D-shell	CP-ES included	74
ES-100MS	RS-232	16550	no	8	modular	CP-ES included	78
DS-200/300S	RS-422/485	16550	no	2	D-shell	none	76
DS-200/300IND	RS-422/485	16550	yes	2	D-shell	none	76
DS-200/300-750	RS-422/485	16750	no	2	D-shell	none	76
QS-200DS	RS-422	16550	no	4	D-shell	CP-QS optional	76
QS-200IND	RS-422	16550	yes	4	D-shell	CP-QS optional	76
QS-200D-750	RS-422	16750	no	4	D-shell	CP-QS optional	76
QS-200MS	RS422	16550	no	4	modular	CP-RJ4 optional	78
QS-300DS	RS-485	16550	no	4	D-shell	CP-QS optional	76
QS-300IND	RS-485	16550	yes	4	D-shell	CP-QS optional	76
QS-300D-750	RS-485	16750	no	4	D-shell	CP-QS optional	76
QS-300MS	RS-485	16550	no	4	modular	CP-RJ4 optional	78
MPA-100	RS-232 synchronous	AMD 85C30	no	1	DB-25	none	81
MPA-102	RS-232 synchronous	AMD 85C30	no	2	DB-25	none	82
MPA-200	RS-422 synchronous	AMD 85C30	no	1	DB-25	none	83
MPA-300	RS-485 synchronous	AMD 85C30	no	1	DB-25	none	83
TV-200S	RS-422	16550	no	2	D-shell	none	80
TV-300S	RS-485	16550	no	2	D-shell	none	80
MMP-100	RS-232/EPP	16550	no	3	D-shell	none	84
DSDP-100	RS-232/EPP	16550	no	4	D-shell	CP-DSDP included	85

COM