

MC34C86

Product Preview

Quad EIA-422-A Line Receiver CMOS

The MC34C86 is a quad differential line receiver designed for digital data transmission over balanced lines. The MC34C86 meets all the requirements of standard EIA-422-A while retaining the low-power characteristics of CMOS.

The MC34C86 has an input sensitivity of 200 mV over the common mode input voltage range of ± 7 V. In addition, each receiver chain has internal hysteresis circuitry to improve noise margin and discourage output instability for slowly changing input waveforms.

The MC34C86 is pin compatible with the MC3486.

All pins are protected against damage due to electrostatic discharges.

- Typical Power Supply Current: 6 mA
- 2000 V ESD Protection on the Inputs and Outputs
- Typical Propagation Delay: 18 ns
- Typical Input Hysteresis: 75 mV
- Meets the Requirements of Standard EIA-422-A
- Operation from Single 5 V Supply
- High Impedance Mode for Outputs Connected to System Buses
- TTL/CMOS Compatible Outputs

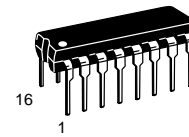

P SUFFIX
PLASTIC DIP
CASE 648

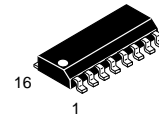

D SUFFIX
SOG PACKAGE
CASE 751B

ORDERING INFORMATION

MC34C86P	Plastic DIP
MC34C86D	SOG Package

BLOCK DIAGRAM

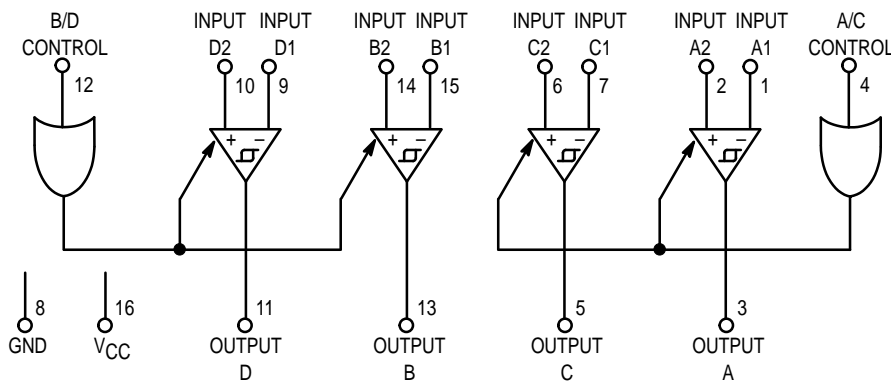

This document contains information on a product under development. Motorola reserves the right to change or discontinue this product without notice.

REV 4
10/95

TRUTH TABLE

Control Input	Input	Output
L	X	Z
H	$V_{ID} \geq V_{TH}$ (Max)	1
H	$V_{ID} \leq V_{TH}$ (Min)	0
H	Open	1

X = Don't Care

H = High Logic State

Z = High Impedance

L = Low Logic State

MAXIMUM RATINGS

Rating	Symbol	Value	Unit
Power Supply Voltage	V_{CC}	7	V
Input Voltage	V_I	± 10	V
Input Differential Voltage	V_{ID}	± 14	V
Enable Control Input Voltage	V_{in}	$V_{CC} + 0.5$	V
Storage Temperature	T_{stg}	-65 to +150	°C
Maximum Current per Output	I_O	± 25	mA
ESD (Human Body Model)		2000	V

This device contains circuitry to protect the inputs against damage due to high static voltages or electric fields; however, it is advised that normal precautions be taken to avoid applications of any voltage higher than the maximum rated voltages to this high impedance circuit.

For proper operation it is recommended that V_{in} and V_{out} be constrained to the range $V_{SS} \leq (V_{in} \text{ or } V_{out}) \leq V_{DD}$. Reliability of operation is enhanced if unused inputs are tied to an appropriate logic voltage level (e.g., either V_{SS} or V_{DD}).

OPERATING CONDITIONS

Rating	Symbol	Min	Max	Unit
Power Supply Voltage	V_{CC}	4.5	5.5	V
Operating Temperature Range	T_A	-40	+85	°C
Input Rise and Fall Time	t_r, t_f	—	500	ns

DC CHARACTERISTICS ($V_{CC} = 4.5$ to 5.5 V, $T_A = -40$ to $+85$ °C, unless otherwise stated) (See Note 1)

Parameter	Symbol	Min	Typ	Max	Unit
Power Supply Current, $V_{CC} = \text{Max}$	I_{CC}	—	6	12	mA
Enable Input Current, $V_{in} = V_{CC}$ or GND	I_L	—	—	± 1.0	μA
Input Voltage — Low Logic State (Enable Control)	V_{IL}	—	—	0.8	V
Input Voltage — High Logic State (Enable Control)	V_{IH}	2	—	—	V
Differential Input Voltage, $-7 \text{ V} < V_{LCM} < 7 \text{ V}$	V_{TH}	0.2	—	—	V
		—	—	-0.2	
Input Hysteresis, $V_{LCM} = 0 \text{ V}$	V_{hys}	—	75	—	mV
Comparator Input Current	I_{in}	—	1.4	—	mA
		—	-2.5	—	
Comparator Input Resistance, $-10 \text{ V} < V_{LCM} < +10 \text{ V}$	R_{in}	4	4.8	—	k Ω
Output Voltage (Low Logic State) $V_{ID} = -1 \text{ V}$, $I_{out} = 6 \text{ mA}$ (Note 2)	V_{OL}	—	0.13	0.33	V
Output Voltage (High Logic State) $V_{ID} = +1 \text{ V}$, $I_{out} = -6 \text{ mA}$ (Note 2)	V_{OH}	3.8	4.8	—	V
Output Leakage Current (High Logic State) $V_{out} = V_{CC}$ or GND	I_{OZ}	-5	—	5	μA

NOTES:

1. All currents into device pins are shown as positive, out of device pins are negative. All voltages referenced to ground unless otherwise noted.
2. See EIA specifications EIA-422-A for exact test conditions.

AC CHARACTERISTICS ($V_{CC} = 4.5$ to 5.5 V, $T_A = -40$ to $+85^\circ\text{C}$, unless otherwise stated)

Parameter	Symbol	Min	Typ	Max	Unit
Propagation Delay Input to Output, $C_L = 50$ pF, $V_{DIFF} = 2.5$ V	t_{PLH} t_{PHL}	—	18	30	ns
Skew = $ t_{PHL} - t_{PLH} $	Skew	—	1	—	ns
Propagation Delay Enable to Output $C_L = 50$ pF, $R_L = 1000 \Omega$, $V_{DIFF} = 2.5$ V	t_{PLZ} t_{PHZ}	—	12	—	ns
Propagation Delay Enable to Output $C_L = 50$ pF, $R_L = 1000 \Omega$, $V_{DIFF} = 2.5$ V	t_{PZL} t_{PZH}	—	14	—	ns

AC TEST CIRCUIT AND SWITCHING TIME WAVEFORMS

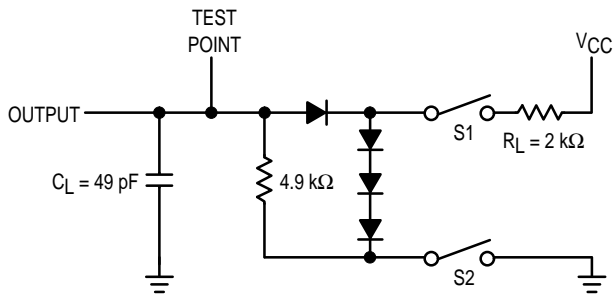

Figure 1. Test Circuit

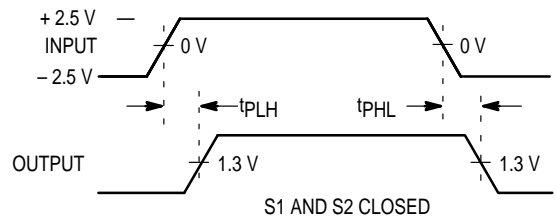

Figure 2. Propagation Delays

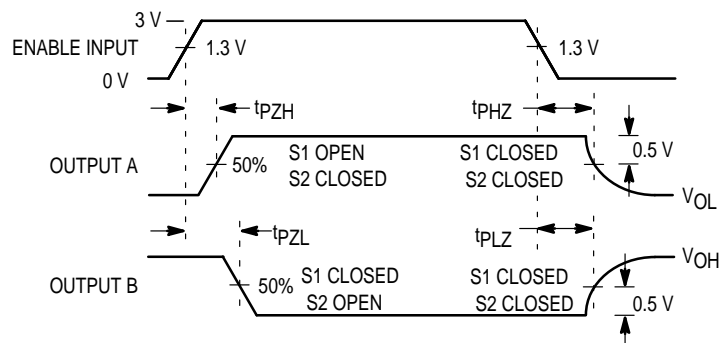

Figure 3. Enable and Disable Times

TYPICAL APPLICATIONS

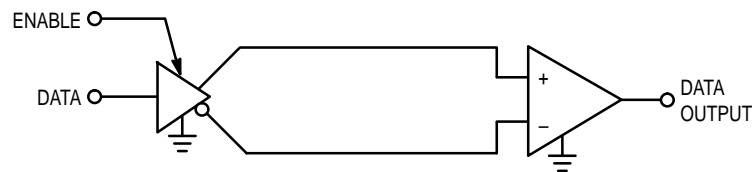
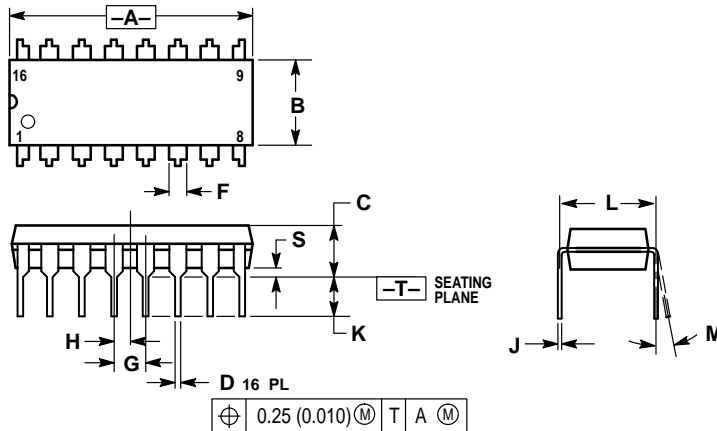

Figure 4. Two-Wire Balanced Systems (EIA-422-A)

PACKAGE DIMENSIONS

P SUFFIX PLASTIC DIP CASE 648-08



NOTES:

- DIMENSIONING AND TOLERANCING PER ANSI Y14.5M, 1982.
- CONTROLLING DIMENSION: INCH.
- DIMENSION L TO CENTER OF LEADS WHEN FORMED PARALLEL.
- DIMENSION B DOES NOT INCLUDE MOLD FLASH.
- ROUNDED CORNERS OPTIONAL.

DIM	INCHES		MILLIMETERS	
	MIN	MAX	MIN	MAX
A	0.740	0.770	18.80	19.55
B	0.250	0.270	6.35	6.85
C	0.145	0.175	3.69	4.44
D	0.015	0.021	0.39	0.53
F	0.040	0.70	1.02	1.77
G	0.100 BSC		2.54 BSC	
H	0.050 BSC		1.27 BSC	
J	0.008	0.015	0.21	0.38
K	0.110	0.130	2.80	3.30
L	0.295	0.305	7.50	7.74
M	0°	10°	0°	10°
S	0.020	0.040	0.51	1.01

D SUFFIX SOG PACKAGE CASE 751B-05

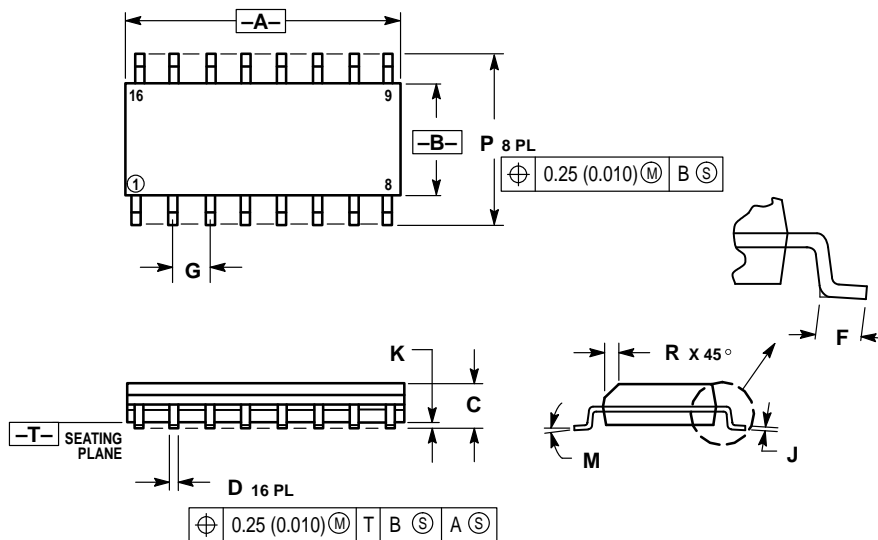

NOTES:

- DIMENSIONING AND TOLERANCING PER ANSI Y14.5M, 1982.
- CONTROLLING DIMENSION: MILLIMETER.
- DIMENSIONS A AND B DO NOT INCLUDE MOLD PROTRUSION.
- MAXIMUM MOLD PROTRUSION 0.15 (0.006) PER SIDE.
- DIMENSION D DOES NOT INCLUDE DAMBAR PROTRUSION. ALLOWABLE DAMBAR PROTRUSION SHALL BE 0.127 (0.005) TOTAL IN EXCESS OF THE D DIMENSION AT MAXIMUM MATERIAL CONDITION.

DIM	MILLIMETERS		INCHES	
	MIN	MAX	MIN	MAX
A	9.80	10.00	0.386	0.393
B	3.80	4.00	0.150	0.157
C	1.35	1.75	0.054	0.068
D	0.35	0.49	0.014	0.019
F	0.40	1.25	0.016	0.049
G	1.27 BSC		0.050 BSC	
J	0.19	0.25	0.008	0.009
K	0.10	0.25	0.004	0.009
M	0°	7°	0°	7°
P	5.80	6.20	0.229	0.244
R	0.25	0.50	0.010	0.019

Motorola reserves the right to make changes without further notice to any products herein. Motorola makes no warranty, representation or guarantee regarding the suitability of its products for any particular purpose, nor does Motorola assume any liability arising out of the application or use of any product or circuit, and specifically disclaims any and all liability, including without limitation consequential or incidental damages. "Typical" parameters can and do vary in different applications. All operating parameters, including "Typicals" must be validated for each customer application by customer's technical experts. Motorola does not convey any license under its patent rights nor the rights of others. Motorola products are not designed, intended, or authorized for use as components in systems intended for surgical implant into the body, or other applications intended to support or sustain life, or for any other application in which the failure of the Motorola product could create a situation where personal injury or death may occur. Should Buyer purchase or use Motorola products for any such unintended or unauthorized application, Buyer shall indemnify and hold Motorola and its officers, employees, subsidiaries, affiliates, and distributors harmless against all claims, costs, damages, and expenses, and reasonable attorney fees arising out of, directly or indirectly, any claim of personal injury or death associated with such unintended or unauthorized use, even if such claim alleges that Motorola was negligent regarding the design or manufacture of the part. Motorola and μ are registered trademarks of Motorola, Inc. Motorola, Inc. is an Equal Opportunity/Affirmative Action Employer.

How to reach us:

USA/EUROPE: Motorola Literature Distribution;
P.O. Box 20912; Phoenix, Arizona 85036. 1-800-441-2447

JAPAN: Nippon Motorola Ltd.; Tatsumi-SPD-JLDC, Toshikatsu Otsuki,
6F Seibu-Butsuryu-Center, 3-14-2 Tatsumi Koto-Ku, Tokyo 135, Japan. 03-3521-8315

MFAX: RMFAX0@email.sps.mot.com - TOUCHTONE (602) 244-6609
INTERNET: http://Design-NET.com

HONG KONG: Motorola Semiconductors H.K. Ltd.; 8B Tai Ping Industrial Park,
51 Ting Kok Road, Tai Po, N.T., Hong Kong. 852-26629298



MC34C86/D

